



LIST PRICE BOOK

January 2, 2017



Ask for Quality ▲ Ask for AMTROL®

Value Added Freight Programs

Part of the Amtrol Advantage™

Amtrol has a variety of unique and flexible freight programs designed to fit the way you do business. From a low \$3,000 Full Freight Allowed (FFA) policy, to our Pallet Freight, Fast Four™ and Quick Ship (QS) services, ordering from Amtrol has never been easier.

\$3,000 Full Freight Allowed (FFA): Any Mix of Products

- Any order attaining \$3,000 Net qualifies for FFA shipment.
- Combine Residential and Commercial products.
- Program applies to Wholesale customers for models in the US List Price Book.
- AK, HI destinations receive freight to the nearest port within the 48 contiguous states.
- Requests for partial shipments below \$3,000 are subject to prepay and add.

Pallet Freight Program: Ships in Three Days

- Full pallet quantities of Therm-X-Trol® ST-5 (75 ea.) and ST-12 (48 ea.), Therm-X-Span® T-5 (75 ea.) and T-12 (48 ea.) and Extrol® EX-15 (75 ea.) and EX-30 (48 ea.).
- Orders received by 12:00 PM EST ship FFA in three business days within the 48 contiguous states.



Fast Four™ Master Packs: Small Quantities Ship in One Day

- Four-packs of Therm-X-Trol ST-5 and ST-12, Therm-X-Span T-5 and T-12 and Extrol EX-15 and EX-30.
- Orders received by 12:00 PM EST ship FFA in one business day via UPS Ground within the 48 contiguous states.



Quick Ship (QS) Program: Ships Next Day

- Select Well-X-Trol®, Therm-X-Trol, Therm-X-Span, Extrol, Fill-Trol®, BoilerMate® and HydroMax® models listed with QS next to the lead time will ship within one business day (no need to call to check inventory).
- Add 3% to order net and specify Quick Ship service.

Terms and Conditions

- All pricing and information contained within the Amtrol 2017 List Price Book is subject to Amtrol's Terms and Conditions. To access a complete copy of the Terms and Conditions, please visit www.amtrol.com.

Standard Leadtimes: Orders May Ship Early Unless Specified

- Standard leadtime is in working days.
- \$30,000 orders and above require a 10-day standard leadtime.
- Longest model standard leadtime applies to entire order.
- Large orders may be subject to longer leadtimes

All dimensions and weights listed are approximate.

Contents

RESIDENTIAL PRODUCTS

Air Purgers, Vents & Valves	13
AIR PURGERS.....	13
AIR VENTS.....	13
MIXING VALVES.....	13
TANK SERVICE CHECK VALVE.....	13
Expansion Tanks - Hydronic	12-13
EX MODELS: EXTROL® INLINE BOILER SYSTEM EXPANSION TANKS.....	12
EX PACKAGES: EXTROL COMBINATION KITS.....	12
FT MODELS: FILL-TROL® TANKS AND AUTOMATIC FILL VALVES.....	12
FT PACKAGES: FILL-TROL COMBINATION KITS.....	12
SX MODELS: EXTROL VERTICAL BOILER SYSTEM EXPANSION TANKS.....	12
RX MODELS: RADIANT EXTROL® HEATING SYSTEM EXPANSION TANKS.....	13
SE MODELS: CLOSED-LOOP SOLAR EXTROL® EXPANSION TANKS.....	13
Expansion Tanks - Water Heater	10
ST MODELS: THERM-X-TROL® INLINE THERMAL EXPANSION TANKS, 5-Year Warranty..	10
ST MODELS: THERM-X-TROL VERTICAL THERMAL EXPANSION TANKS.....	10
T MODELS: THERM-X-SPAN® INLINE THERMAL EXPANSION TANKS, 1-Year Warranty....	10
Hot Water Makers®	14-15
BOILERMATE® INDIRECT-FIRED WATER HEATERS.....	14
HOT WATER MAKER REPLACEMENT PARTS.....	14
HYDROMAX® INDIRECT-FIRED WATER HEATERS.....	14
PREMIER HOT WATER STORAGE TANKS.....	15
PREMIER™ INDIRECT-FIRED WATER HEATERS.....	15
Pressure Boosters	9
HP SERIES BOOSTER SYSTEM REPLACEMENT PARTS.....	9
RP MODELS: AMTROL PRESSURISER® CITY WATER PRESSURE BOOSTER SYSTEMS....	9
Retention Tanks - Epoxy-Lined	8
ERTG MODELS: EPOXY-LINED REPLACEMENT FOR GALVANIZED TANKS, DESERT TAN ..	8
Reverse Osmosis Storage Tanks	7
RO MODELS: REVERSE OSMOSIS STORAGE TANKS.....	7
Tube Straps & Hangers	11
Water Hammer Arrestors	10
Well Tank Accessories	8
DIGITAL PRESSURE CONTROL.....	8
DURABASE® TANK SPACER.....	8
PUMP MOUNTING STAND.....	8
TOUCH-UP PAINT.....	8
Well Tanks, 125 PSI, 5-Year Warranty	6-7
CH MODELS: CHAMPION® VERTICAL STAND, DARK BLUE.....	6
WF MODELS: WEL-FLO® VERTICAL STAND, LIGHT GRAY.....	6
PL MODELS: PRO-LINE® VERTICAL STAND, TAN.....	7
Well-X1® System Well Tank & Digital Control	6
WX1 MODELS: READY-TO-RUN WITH GUARDIAN CP® DIGITAL PRESSURE CONTROL....	6
Well-X-Trol® Well Tanks, 150 PSI, 7-Year Warranty	4-6
WX MODELS: VERTICAL STAND.....	4
WX MODELS: VERTICAL STAND WITH PRO ACCESS®.....	4
WX MODELS: HORIZONTAL.....	5
WX MODELS: INLINE.....	5
WX MODELS: VERTICAL WITH DURABASE® COMPOSITE STAND.....	5
WX MODELS: WALL HUNG WITH VFD CONTROL BRACKET.....	5
WX MODELS: UNDERGROUND.....	6

Letters A-K denote product categories.

Prices and contents are subject to change without notice.

Visit www.amtrol.com to download the most current version of the List Price Book.

COMMERCIAL PRODUCTS

Air & Dirt Separators & Inline Air Purgers	22
AIR & DIRT SEPARATORS, ASME.....	22
INLINE AIR PURGERS.....	22
Air Separators	20
TANGENTIAL AIR SEPARATORS, LESS STRAINER, ASME.....	20
Air Separators & Purgers	21
TANGENTIAL AIR SEPARATORS, WITH STRAINER, ASME.....	21
Air Vents & Plain Steel Tanks	23
AC MODELS: PLAIN STEEL COMPRESSION TANKS, ASME.....	23
HIGH CAPACITY AIR VENT.....	23
Chilled Water Buffer Tanks	24
CWBT MODELS: CHILLED WATER BUFFER TANKS, ASME.....	24
Commercial Accessories	34
REPLACEMENT BLADDERS.....	34
Extrol® Bladder Tanks	18-19
L MODELS: FULL ACCEPTANCE BLADDER, TOP CONNECTION, ASME.....	18
LBC MODELS: PARTIAL ACCEPTANCE BLADDER, BOTTOM CONNECTION, ASME.....	19
Extrol® Diaphragm Tanks	16-17
AX MODELS: HORIZONTAL DIAPHRAGM TYPE, ASME.....	16
AX-V MODELS: VERTICAL DIAPHRAGM TYPE, ASME.....	17
Fire Protection Products	32
FPT MODELS: FIRE-X-TROL® SPRINKLER SYSTEM EXPANSION TANKS, 175 PSI.....	32
SPT MODELS: SURGE-TROL® SPRINKLER SYSTEM SURGE SUPPRESSORS, 275 PSI..	32
Hot Water Buffer Tanks	25
HWBT MODELS: HOT WATER BUFFER TANKS, ASME.....	25
Shock Suppressors & Commercial Accessories	33
AC MODELS: PLAIN STEEL COMPRESSION TANKS, ASME.....	33
D MODELS: DIATROL® SHOCK SUPPRESSORS, 250 PSI, ASME.....	33
HIGH CAPACITY AIR VENT.....	33
Therm-X-Trol® Bladder Tanks	27-28
ST-C (ASME) and ST (NON-ASME) MODELS: FULL ACCEPTANCE BLADDER.....	27
ST-CL (ASME) and ST-L (NON-ASME) MODELS: PARTIAL ACCEPTANCE BLADDER.....	28
Therm-X-Trol® Diaphragm Tanks	26
ST MODELS: DIAPHRAGM TYPE, ASME.....	26
Well-X-Trol® Bladder Tanks	30-31
WX-C (ASME) and WX (NON-ASME) MODELS: FULL ACCEPTANCE BLADDER.....	30-31
WX-CL (ASME) and WX-L (NON-ASME) MODELS: PARTIAL ACCEPTANCE BLADDER, 125 PSI.....	31
Well-X-Trol® Diaphragm Tanks	29
WX-C (ASME) and WX (NON-ASME) MODELS: DIAPHRAGM TYPE.....	29
Index	35-37
Frequently Used Part Numbers	38-39
Quick Sizing	40
Notes	41-42
Warranty	43

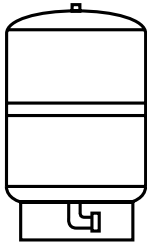

Scan with smart phone for current version.

WX MODELS: VERTICAL STAND
A

QUICK SHIP ELIGIBLE

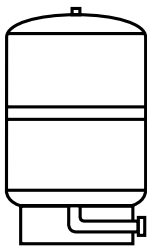
Model Number	Description	Volume (Gal)	Max Acceptance Factor	Shipping Dimensions (In)			Shipping Weight (Lbs)	UPC 642031	Standard Leadtime (Days)	List Price (USD)
				L	W	H				
WX-201	BLUE	14	0.81	15	15	25	25	644411	5	\$351.00
WX-202	BLUE	20	0.57	15	15	32	32	644442	5 QS	\$432.00
WX-202XL	BLUE	26	0.44	15	15	39	39	644503	5	\$456.00
WX-203	BLUE	32	0.35	15	15	47	47	644572	5 QS	\$737.00
WX-205	BLUE	34	1.00	22	22	30	57	644657	5 QS	\$807.00
WX-250	BLUE	44	0.77	22	22	36	65	644718	5 QS	\$935.00
WX-251	BLUE	62	0.55	22	22	47	87	644770	5 QS	\$1,105.00
WX-255	BLUE	81	0.41	22	22	57	109	644862	5 QS	\$1,187.00
WX-252	BLUE (TALL)	86	0.39	22	22	62	107	644831	5 QS	\$1,422.00
WX-302	BLUE (SHORT)	86	0.54	26	26	47	106	644947	5 QS	\$1,311.00
WX-350	BLUE	119	0.39	26	26	62	146	645005	5 QS	\$1,868.00
WX-201-T	TAN	14	0.81	15	15	25	25	645081	5	\$351.00
WX-202-T	TAN	20	0.57	15	15	32	32	644459	5	\$432.00
WX-202XL-T	TAN	26	0.44	15	15	39	39	644510	5	\$456.00
WX-203-T	TAN	32	0.35	15	15	47	47	644589	5	\$737.00
WX-205-T	TAN	34	1.00	22	22	30	57	644664	5	\$807.00
WX-250-T	TAN	44	0.77	22	22	36	65	644725	5	\$935.00
WX-251-T	TAN	62	0.55	22	22	47	87	644787	5	\$1,105.00
WX-255-T	TAN	81	0.41	22	22	57	109	644879	5	\$1,187.00
WX-302-T	TAN	86	0.54	26	26	47	106	644954	5	\$1,311.00
WX-350-T	TAN	119	0.39	26	26	62	146	645012	5	\$1,868.00
WX-201-G	GRAY	14	0.81	15	15	25	25	650634	5	\$351.00
WX-202-G	GRAY	20	0.57	15	15	32	32	646132	5	\$432.00
WX-202XL-G	GRAY	26	0.44	15	15	39	39	646149	5	\$456.00
WX-203-G	GRAY	32	0.35	15	15	47	47	646156	5	\$737.00
WX-205-G	GRAY	34	1.00	22	22	30	57	646163	5	\$807.00
WX-250-G	GRAY	44	0.77	22	22	36	65	646170	5	\$935.00
WX-251-G	GRAY	62	0.55	22	22	47	87	646187	5	\$1,105.00
WX-255-G	GRAY	81	0.41	22	22	57	109	646194	5	\$1,187.00
WX-302-G	GRAY	86	0.54	26	26	47	106	646200	5	\$1,311.00
WX-350-G	GRAY	119	0.39	26	26	62	146	646217	5	\$1,868.00

WX MODELS: VERTICAL STAND WITH PRO ACCESS®
A

WX-202PA	BLUE	20	0.57	15	15	32	33	644473	5	\$463.00
WX-202XLP	BLUE	26	0.44	15	15	39	40	644541	5	\$489.00
WX-203PA	BLUE	32	0.35	15	15	47	48	644602	5	\$793.00
WX-205PA	BLUE	34	1.00	22	22	30	59	644688	5	\$867.00
WX-250PA	BLUE	44	0.77	22	22	36	67	644749	5	\$1,003.00
WX-251PA	BLUE	62	0.55	22	22	47	88	644800	5	\$1,184.00
WX-255PA	BLUE	81	0.41	22	22	57	111	644893	5	\$1,271.00
WX-302PA	BLUE	86	0.54	26	26	47	108	644978	5	\$1,402.00
WX-350PA	BLUE	119	0.39	26	26	62	148	645036	5	\$1,995.00
WX-202PA-T	TAN	20	0.57	15	15	32	33	644480	5	\$463.00
WX-202XLP	TAN	26	0.44	15	15	39	40	644558	5	\$489.00
WX-203PA-T	TAN	32	0.35	15	15	47	48	644619	5	\$793.00
WX-205PA-T	TAN	34	1.00	22	22	30	59	644695	5	\$867.00
WX-250PA-T	TAN	44	0.77	22	22	36	67	644756	5	\$1,003.00
WX-251PA-T	TAN	62	0.55	22	22	47	88	644817	5	\$1,184.00
WX-255PA-T	TAN	81	0.41	22	22	57	111	644909	5	\$1,271.00
WX-302PA-T	TAN	86	0.54	26	26	47	108	644985	5	\$1,402.00
WX-350PA-T	TAN	119	0.39	26	26	62	148	645043	5	\$1,995.00
WX-202PA-G	GRAY	20	0.57	15	15	32	33	646224	5	\$463.00
WX-202XLP	GRAY	26	0.44	15	15	39	40	646231	5	\$489.00
WX-203PA-G	GRAY	32	0.35	15	15	47	48	646248	5	\$793.00
WX-205PA-G	GRAY	34	1.00	22	22	30	59	646255	5	\$867.00
WX-250PA-G	GRAY	44	0.77	22	22	36	67	646262	5	\$1,003.00
WX-251PA-G	GRAY	62	0.55	22	22	47	88	646279	5	\$1,184.00
WX-255PA-G	GRAY	81	0.41	22	22	57	111	646286	5	\$1,271.00
WX-302PA-G	GRAY	86	0.54	26	26	47	108	646293	5	\$1,402.00
WX-350PA-G	GRAY	119	0.39	26	26	62	148	646309	5	\$1,995.00

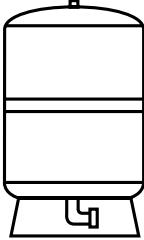
WX MODELS: VERTICAL WITH DURABASE® COMPOSITE STAND
A

Model Number	Description	Volume (Gal)	Max Acceptance Factor	Shipping Dimensions (In)			Shipping Weight (Lbs)	UPC 642031	Standard Leadtime (Days)	List Price (USD)	
				L	W	H					
	WX-201D	BLUE	14	0.81	15	15	25	25	645159	5	\$351.00
	WX-202D	BLUE	20	0.57	15	15	32	32	645173	5	\$432.00
	WX-202XLD	BLUE	26	0.44	15	15	39	39	645210	5	\$456.00
	WX-203D	BLUE	32	0.35	15	15	47	47	645241	5	\$737.00
	WX-205D	BLUE	34	1.00	22	22	30	57	645289	5	\$807.00
	WX-250D	BLUE	44	0.77	22	22	36	65	645319	5	\$935.00
	WX-251D	BLUE	62	0.55	22	22	47	87	645340	5	\$1,105.00
	WX-255D	BLUE	81	0.41	22	22	57	109	645371	5	\$1,187.00
	WX-302D	BLUE	86	0.54	26	26	47	106	645418	5	\$1,311.00
	WX-350D	BLUE	119	0.39	26	26	62	146	645449	5	\$1,868.00
WX-201D-T	TAN	14	0.81	15	15	25	25	645166	5	\$351.00	
WX-202D-T	TAN	20	0.57	15	15	32	32	645197	5	\$432.00	
WX-202XLD-T	TAN	26	0.44	15	15	39	39	645227	5	\$456.00	
WX-203D-T	TAN	32	0.35	15	15	47	47	645258	5	\$737.00	
WX-205D-T	TAN	34	1.00	22	22	30	57	645296	5	\$807.00	
WX-250D-T	TAN	44	0.77	22	22	36	65	645326	5	\$935.00	
WX-251D-T	TAN	62	0.55	22	22	47	87	645357	5	\$1,105.00	
WX-255D-T	TAN	81	0.41	22	22	57	109	645388	5	\$1,187.00	
WX-302D-T	TAN	86	0.54	26	26	47	106	645425	5	\$1,311.00	
WX-350D-T	TAN	119	0.39	26	26	62	146	645456	5	\$1,868.00	
WX-201D-G	GRAY	14	0.81	15	15	25	25	648686	5	\$351.00	
WX-202D-G	GRAY	20	0.57	15	15	32	32	648693	5	\$432.00	
WX-202XLD-G	GRAY	26	0.44	15	15	39	39	648709	5	\$456.00	
WX-203D-G	GRAY	32	0.35	15	15	47	47	648716	5	\$737.00	
WX-205D-G	GRAY	34	1.00	22	22	30	57	648723	5	\$807.00	
WX-250D-G	GRAY	44	0.77	22	22	36	65	648730	5	\$935.00	
WX-251D-G	GRAY	62	0.55	22	22	47	87	648747	5	\$1,105.00	
WX-255D-G	GRAY	81	0.41	22	22	57	109	648754	5	\$1,187.00	
WX-302D-G	GRAY	86	0.54	26	26	47	106	648761	5	\$1,311.00	
WX-350D-G	GRAY	119	0.39	26	26	62	146	648778	5	\$1,868.00	

WX MODELS: INLINE
A

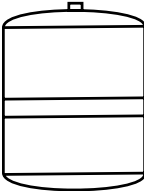
 QUICK SHIP ELIGIBLE	WX-101	BLUE	2.0	0.45	8	8	13	5	644053	5 QS	\$109.00
	WX-102	BLUE	4.4	0.55	11	11	15	9	644084	5 QS	\$149.00
	WX-103	BLUE	7.6	0.43	11	11	22	15	644114	5 QS	\$243.00
	WX-104	BLUE	10.3	1.00	15	15	18	20	644145	5	\$271.00
	WX-200	BLUE	14.0	0.81	15	15	22	22	644169	5	\$288.00
	WX-101-G	GRAY	2.0	0.45	8	8	13	5	646118	5	\$109.00
	WX-102-G	GRAY	4.4	0.55	11	11	15	9	646125	5	\$149.00
	WX-103-G	GRAY	7.6	0.43	11	11	22	15	650603	5	\$243.00
	WX-104-G	GRAY	10.3	1.00	15	15	18	20	650610	5	\$271.00
	WX-200-G	GRAY	14.0	0.81	15	15	22	22	650627	5	\$288.00

WX MODELS: HORIZONTAL
A

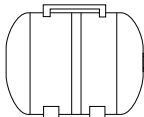
	WX-102PS	BLUE WITH PUMP STAND	4.4	0.55	15	11	12	13	644190	5	\$226.00
	WX-105PS	BLUE WITH PUMP STAND	5.3	0.80	18	11	12	15	644220	5	\$295.00
	WX-110PS	BLUE WITH PUMP STAND	7.4	0.56	23	11	12	18	649102	5	\$297.00
	WX-200PS	BLUE WITH PUMP STAND	14.0	0.81	22	15	16	29	644268	5	\$517.00
	WX-202PS	BLUE WITH PUMP STAND	20.0	0.57	30	15	16	35	649119	5	\$648.00
	WX-202H	BLUE W/O PUMP STAND	20.0	0.57	30	15	16	33	644299	5	\$456.00

WX MODELS: WALL HUNG WITH VFD CONTROL BRACKET
A

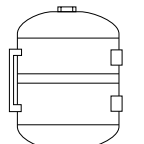
	WX-102VFD	BLUE WITH VFD BRACKET	4.4	0.55	15	11	12	13	649454	5	\$261.00
---	-----------	-----------------------	-----	------	----	----	----	----	--------	---	----------

WX MODELS: UNDERGROUND

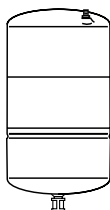
A

Model Number	Description	Volume (Gal)	Max Acceptance Factor	Shipping Dimensions (In)			Shipping Weight (Lbs)	UPC 642031	Standard Leadtime (Days)	List Price (USD)
				L	W	H				
WX-200UG	SPECIAL UG COATING	14	0.81	15	15	23	22	644312	5	\$446.00
WX-202UG	SPECIAL UG COATING	20	0.57	15	15	30	30	644336	5	\$643.00
WX-250UG	SPECIAL UG COATING	44	0.77	22	22	33	60	644367	5	\$1,248.00
WX-251UG	SPECIAL UG COATING	62	0.55	22	22	44	83	644381	5	\$1,484.00

Well-X1® System Well Tank & Digital Control

WX1 MODELS: READY-TO-RUN WITH GUARDIAN CP® DIGITAL PRESSURE CONTROL

A

WX1-250D	BLUE	44	0.77	22	22	44	80	650238	10	\$1,457.00
WX1-251D	BLUE	62	0.55	22	22	55	103	650221	10	\$1,628.00
WX1-302D	BLUE	86	0.54	26	26	55	134	650214	10	\$1,835.00

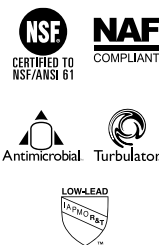

Pallet Quantity: WX-101: 75, WX-102: 48, WX-103: 32, WX-104 & WX-200: 18
 WX-102-PS: 32, WX-105-PS: 72, WX-110PS: 32, WX-200-PS: 18, WX-202PS: 18
 WX-200UG & WX-202UG: 18, WX-250UG & WX-251UG: 4
 WX-201 and WX-202: 18, WX-202XL & WX-203: 9, WX-205 through WX-350: 4

Connection: Stainless Steel: WX-101 through WX-103, WX-102PS through WX-110PS: 3/4" NPTM, WX-104, WX-200, WX-200PS, WX-202PS and WX-202H: 1" NPTM, WX-200UG, WX-202UG and WX-201 through WX-203: 1" NPTF, WX-205 through WX-350, WX250UG and WX-251UG: 1-1/4" NPTF

Factory Precharge: All WX and WX1 Models: 38 PSI

Working Pressure: All WX and WX1 Models: except WX-252: 150 PSI; WX252: 100 PSI

Warranty: All WX Models: 7-Year Limited; WX1: 7-Year Limited (Tank), 2-Year Limited (Control).

Well Tanks, 125 PSI, 5-Year Warranty

CH MODELS: CHAMPION® VERTICAL STAND, DARK BLUE

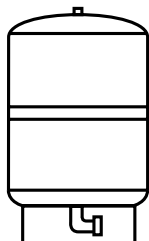
A

Model Number	Description	Volume (Gal)	Max Acceptance Factor	Shipping Dimensions (In)			Shipping Weight (Lbs)	UPC 642031	Standard Leadtime (Days)	List Price (USD)
				L	W	H				
CH-14	CH3001	14	0.81	15	15	25	22	530295	10	\$321.00
CH-20	CH4202	20	0.57	15	15	32	28	529329	10	\$418.00
CH-26	CH6000	26	0.44	15	15	39	34	550798	10	\$442.00
CH-32	CH8003	32	0.35	15	15	47	40	530318	10	\$714.00
CH-34	CH8205	34	1.00	22	22	30	50	530332	10	\$784.00
CH-44	CH10050	44	0.77	22	22	36	57	530257	10	\$905.00
CH-62	CH12051	62	0.55	22	22	47	75	530264	10	\$1,067.00
CH-81	CH17255	81	0.41	22	22	57	92	550705	10	\$1,148.00
CH-86	CH17002	86	0.54	26	26	47	99	530271	10	\$1,269.00
CH-119	CH22050	119	0.39	26	26	62	133	530288	10	\$1,809.00

WF MODELS: WEL-FLO® VERTICAL STAND, LIGHT GRAY

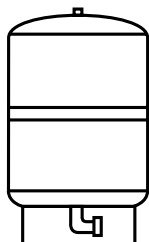
A

WF-14	WF45	14	0.81	15	15	25	22	406736	10	\$321.00
WF-20	WF60	20	0.57	15	15	32	28	406767	10	\$418.00
WF-26	WF80	26	0.44	15	15	39	34	550828	10	\$442.00
WF-32	WF100	32	0.35	15	15	47	40	406620	10	\$714.00
WF-34	WF110	34	1.00	22	22	30	50	406637	10	\$784.00
WF-44	WF140	44	0.77	22	22	36	57	406651	10	\$905.00
WF-62	WF200	62	0.55	22	22	47	75	406675	10	\$1,067.00
WF-81	WF255	81	0.41	22	22	57	92	550675	10	\$1,148.00
WF-86	WF260	86	0.54	26	26	47	99	406699	10	\$1,269.00
WF-119	WF360	119	0.39	26	26	62	133	406705	10	\$1,809.00

PL MODELS: PRO-LINE® VERTICAL STAND, TAN A

Model Number	Description	Volume (Gal)	Max Acceptance Factor	Shipping Dimensions (In)			Shipping Weight (Lbs)	UPC 642031	Standard Leadtime (Days)	List Price (USD)	
				L	W	H					
	PL-14	CA3001	14	0.81	15	15	25	22	409935	10	\$321.00
	PL-20	CA4202	20	0.57	15	15	32	28	409942	10	\$418.00
	PL-26	CA6000	26	0.44	15	15	39	34	550804	10	\$442.00
	PL-32	CA8003	32	0.35	15	15	47	40	409959	10	\$714.00
	PL-34	CA8205	34	1.00	22	22	30	50	400024	10	\$784.00
	PL-44	CA10050	44	0.77	22	22	36	57	399984	10	\$905.00
	PL-62	CA12051	62	0.55	22	22	47	75	399991	10	\$1,067.00
	PL-81	CA17255	81	0.41	22	22	57	92	550712	10	\$1,148.00
	PL-86	CA17002 (SHORT)	86	0.54	26	26	47	99	660008	10	\$1,269.00
	PL-119	CA22050	119	0.39	26	26	62	133	400017	10	\$1,809.00



Pallet Quantity: 14 & 20 Gal: 18, 26 & 32 Gal: 9, 34 through 119 Gal: 4
Connection: Stainless Steel: 14 through 32 Gal: 1" NPTF, 34 through 119 Gal: 1-1/4" NPTF
Factory Precharge: All CH, WF & PL Models: 38 PSI
Working Pressure: CH, WF & PL: 125 PSI
Warranty: All CH, WF & PL Models: 5-Year Limited

Reverse Osmosis Storage Tanks

RO MODELS: REVERSE OSMOSIS STORAGE TANKS A

Model Number	Description	Color	PSI	Other	Total Volume (Gal)	Connection Size (In)	Shipping Weight (Lbs)	UPC 642031	Standard Leadtime* (Days)	List Price (USD)	
											<p>RO-2 THROUGH RO-10</p> <p>BUMP BASE</p> <p>RO-14 (143-198)</p> <p>RO-14 (143-293) THROUGH RO-119</p>
RO-2	140-653	BLUE	20 PS	PLASTIC STAND	2	1/4	5	123077	10	\$180.00	
RO-3	140S723	WHITE	5 PSI	PLASTIC STAND	3	1/4	7	462855	10	\$163.00	
RO-3	140S725	WHITE	5 PSI	BUMP BASE	3	1/4	7	578808	10	\$163.00	
RO-4	141S343	BLUE	5 PSI	PLASTIC STAND	4	1/4	9	462862	10	\$245.00	
RO-4	141S344	WHITE	5 PSI	PLASTIC STAND	4	1/4	9	462879	10	\$245.00	
RO-4	141S351	WHITE	5 PSI	BUMP BASE	4	1/4	9	527165	10	\$245.00	
RO-4	141S352	BLUE	5 PSI	BUMP BASE	4	1/4	9	528179	10	\$245.00	
RO-10	143-132	BLUE	5 PSI	PLASTIC STAND	10	3/4	20	129116	10	\$467.00	
RO-14	143-198	BLUE	15 PSI		14	3/4	24	129710	10	\$499.00	
RO-14	143-293	BLUE	15 PSI		14	1/4	24	391490	10	\$499.00	
RO-20PA	144-251	BLUE	15 PSI	PRO ACCESS® CONN	20	3/4	32	563026	10	\$603.00	
RO-20	144-120	BLUE	15 PSI		20	3/4	32	130716	10	\$563.00	
RO-34PA	147-220	BLUE	15 PSI	PRO ACCESS CONN	34	1-1/4	61	563033	10	\$1,129.00	
RO-34	147-47	BLUE	15 PSI		34	1-1/4	61	138293	10	\$1,056.00	
RO-44PA	147-221	BLUE	15 PSI	PRO ACCESS CONN	44	1-1/4	86	563040	10	\$1,220.00	
RO-44	147-69	BLUE	15 PSI		44	1-1/4	86	138422	10	\$1,130.00	
RO-86PA	150-86	BLUE	15 PSI	PRO ACCESS CONN	86	1-1/4	123	563057	10	\$1,828.00	
RO-86	150-6	BLUE	15 PSI		86	1-1/4	123	139931	10	\$1,713.00	
RO-119PA	151-57	BLUE	15 PSI	PRO ACCESS CONN	119	1-1/4	166	563064	10	\$2,605.00	

*Order quantities over 100 each require a 15 day lead time



Pallet Quantity: RO-2: 75, RO-3: 60, RO-4: 48, RO-10 through 20: 18, RO-34 through 119: 4
Connection: Stainless Steel
Warranty: 5-Year Limited

ERTG MODELS: EPOXY-LINED REPLACEMENT FOR GALVANIZED TANKS, DESERT TAN

A

Model Number	Description	Volume (Gal)	Shipping Dimensions (In)			Shipping Weight (Lbs)	UPC 642031	Standard Leadtime (Days)	List Price (USD)
			L	W	H				
ERTG-12A		12	12	12	26	31	684790	10	\$311.00
ERTG-21A		21	16	16	27	45	684806	10	\$324.00
ERTG-30A		30	16	16	39	60	684813	10	\$404.00
ERTG-42TA	TALL	42	16	16	53	77	684820	10	\$369.00
ERTG-42SA	SHORT	42	20	20	36	70	684837	10	\$389.00
ERTG-82A		82	20	20	64	112	684844	10	\$539.00
ERTG-120A		120	24	24	66	142	684851	10	\$713.00
ERTG-220A		220	30	30	78	346	636249	10	\$1,796.00
ERTG-315A		315	36	36	78	453	684868	10	\$2,503.00

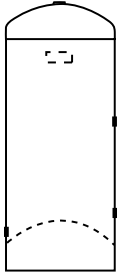
Warranty: 3-Year Limited

Well Tank Accessories

DIGITAL PRESSURE CONTROL

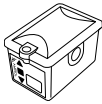

146-832	GUARDIAN CP® DIGITAL PRESSURE CONTROL	4	8	4	2	639889	1	\$233.00
146-2350	EXTERNAL GROUNDING KIT	2	2	2	1	638748	5	\$75.50

DURABASE® TANK SPACER



DURABASE-15	FITS AMTROL 15" STEEL STAND MODELS	16	16	6	2	648433	5	\$25.70
DURABASE-22	FITS AMTROL 22" & 26" STEEL STAND MODELS	23	23	7	3	648440	5	\$33.40

PUMP MOUNTING STAND



UNVDKT	UNIVERSAL VERTICAL TANKS	8	10	3	3	049708018405	5	\$51.00
--------	--------------------------	---	----	---	---	--------------	---	---------

TOUCH-UP PAINT

140-127	WELL-X-TROL® BLUE 4.5 OZ SPRAY	2	2	4	1	121486	5	\$28.00
---------	--------------------------------	---	---	---	---	--------	---	---------

Warranty: Guardian CP: 2-Year Limited, All Well Tank Accessories: 1-Year Limited

RP MODELS: AMTROL PRESSURISER® CITY WATER PRESSURE BOOSTER SYSTEMS
D

Model Number	Description	Volume (Gal)	Shipping Dimensions (In)			Shipping Weight (Lbs)	UPC 642031	Standard Leadtime (Days)	List Price (USD)
			L	W	H				
RP-10HP	2201-37 10 GPM SYSTEM	14	17	17	30	50	574732	5	\$1,553.00
RP-15HP	2201-39 15 GPM SYSTEM	20	17	17	38	55	574886	5	\$1,667.00
RP-25HP	2201-28 25 GPM SYSTEM	34	22	22	39	90	499295	5	\$2,447.00

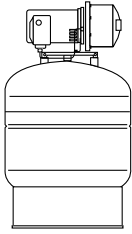
HP SERIES BOOSTER SYSTEM REPLACEMENT PARTS
I



245-59	PUMP RP-10HP					23	593467	1	\$1,097.00
245-60	PUMP RP-15HP					23	593474	1	\$1,097.00
245-61	PUMP RP-25HP					23	593481	1	\$1,097.00
2201R37	TANK RP-10	14				25	618634	1	\$749.00
2201R39	TANK RP-15	20				33	618658	1	\$777.00
2201R28	TANK RP-25	34				61	618719	1	\$1,026.00
2201N002	SHAFT SEAL KIT - All Models					1	447371	1	\$36.50
2201N003	IMPELLER RP-10					1	447418	1	\$123.00
2201N020	IMPELLER RP-15					1	447425	1	\$105.00
2201N021	IMPELLER RP-25					1	447432	1	\$113.00
2201N006	O-RING REBUILD KIT - All Models					1	447401	1	\$90.40
2201N010	PUMP VENTURI - All Models					1	466655	1	\$80.30
2201N022	PUMP GUIDE VANE - All Models					1	447449	1	\$69.30
113-3	GUARDIAN CP® UPGRADE KIT					2	645654	1	\$417.00
146-832	GUARDIAN CP DIGITAL PRESSURE CONTROL					2	639899	1	\$233.00



Pallet Quantity: RP-10HP through RP-25HP: 4
Connection: Stainless Steel: RP-10HP through RP-25HP: 1-1/4" NPTF In, 1" NPTF Out
Warranty: RP-10HP through RP-25HP: 2-Year Limited, Guardian CP: 2-Year Limited, All Replacement Parts: 1 Year Limited

ST MODELS: THERM-X-TROL® INLINE THERMAL EXPANSION TANKS, 5-Year Warranty

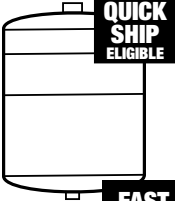
B

Model Number	Description	Volume (Gal)	Max Acceptance Volume (Gal)	Shipping Dimensions (In)			Shipping Weight (Lbs)	UPC 642031	Standard Leadtime (Days)	List Price (USD)	
				L	W	H					
 <p>QUICK SHIP ELIGIBLE</p>	ST-5	140N43 HIGH-GLOSS TAN	2.0	0.9	8	8	13	5	395665	5 QS	\$78.40
	ST-8	140N738 HIGH-GLOSS TAN	3.2	1.9	9	9	15	7	551405	5	\$91.80
	ST-12	141N43 HIGH-GLOSS TAN	4.4	3.2	11	11	15	9	395672	5 QS	\$105.00
 <p>FAST FOUR</p>	ST-5-FF	140N43-FF FAST FOUR 4PC MASTER PACK	2.0	0.9	17	17	13	20	639349	1FF	\$314.00
	ST-12-FF	141N43-FF FAST FOUR 4PC MASTER PACK	4.4	3.2	24	24	17	36	639370	1FF	\$420.00

ST MODELS: THERM-X-TROL VERTICAL THERMAL EXPANSION TANKS

B

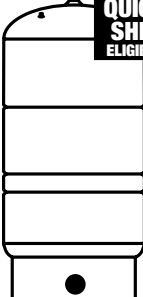
Model Number	Description	Volume (Gal)	Max Acceptance Volume (Gal)	Shipping Dimensions (In)			Shipping Weight (Lbs)	UPC 642031	Standard Leadtime (Days)	List Price (USD)	
				L	W	H					
 <p>QUICK SHIP ELIGIBLE</p>	ST-25V	143N164 TAN	10.3	10.3	15	15	19	23	395689	5 QS	\$299.00
	ST-30V	143N273 TAN	14.0	11.3	15	15	24	25	395696	5	\$366.00
	ST-42V	144N177 TAN	20.0	11.4	15	15	32	33	395702	5	\$436.00
	ST-60V	147N130 TAN	34.0	34.0	22	22	30	61	395719	5	\$564.00
	ST-80V	147N131 TAN	44.0	33.9	22	22	36	69	395726	5	\$774.00
	ST-180V	148N118 TAN	62.0	34.1	22	22	47	92	395733	5	\$932.00
	ST-200V	149-166 TAN	81.0	33.2	22	22	56	103	633552	5	\$984.00
	ST-210V	150N32 TAN	86.0	46.4	26	26	47	123	395740	5	\$1,059.00

T MODELS: THERM-X-SPAN® INLINE THERMAL EXPANSION TANKS, 1-Year Warranty

B

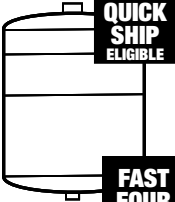
Model Number	Description	Volume (Gal)	Max Acceptance Volume (Gal)	Shipping Dimensions (In)			Shipping Weight (Lbs)	UPC 642031	Standard Leadtime (Days)	List Price (USD)	
				L	W	H					
 <p>QUICK SHIP ELIGIBLE</p> <p>FAST FOUR</p>	T-5	140-735 LIGHT PRIMER TAN	2.0	0.9	8	8	13	5	548498	5 QS	\$47.50
	T-12	141-363 LIGHT PRIMER TAN	4.4	3.2	11	11	15	9	560889	5 QS	\$60.40
	T-5-FF	140-735-FF FAST FOUR 4PC MASTER PACK	2.0	0.9	17	17	13	20	639356	1FF	\$191.00
	T-12-FF	141-363-FF FAST FOUR 4PC MASTER PACK	4.4	3.2	24	24	17	36	639387	1FF	\$242.00

Water Hammer Arrestors

WATER HAMMER ARRESTORS (SHOCK SUPPRESSORS)

K

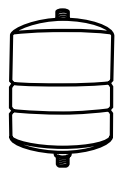
Model Number	Description	Volume (Gal)	Shipping Dimensions (In)			Shipping Weight (Lbs)	UPC 642031	Standard Leadtime (Days)	List Price (USD)	
			L	W	H					
 <p>Mini-Trol®</p>	513P01	MINI-TROL COMPOSITE	Size A	4	4	5	1	670137	5	\$46.40
	 <p>Diatrol®</p>	537-1	DIATROL #537	0.8	6	6	9	3	202932	5
541-1		DIATROL #541	1.0	6	6	12	5	203564	5	\$201.00



Pallet Quantity: ST-5 & T-5: 75, ST-8: 60, ST-12 & T-12: 48
ST-25V, 30V & 42V: 18, ST-60V through ST-210V: 4

Connection: Stainless Steel: ST-5 through ST-12 & T-5 through T-12: 3/4" NPTM, ST-25V through ST-42V: 3/4" NPTF, ST-60V through ST-210V: 1-1/4" NPTF

Warranty: ST-5 through ST-12 & ST-25V: 5-Year Limited, ST-30V through ST-210V: 1-Year Limited, T-5 & T-12: 1-Year Limited, Mini-Trol & Diatrol: 5-Year Limited



Maximum Operating Temp: Therm-X-Trol, Therm-X-Span and Diatrol: 200 F; Mini-Trol: 180° F Intermittent.
Maximum Working Pressure: 150 PSI

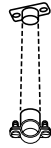

TUBE HANGERS: 601 SERIES

Model Number	Description	Case Qty		Shipping Weight (Lbs)	UPC 642031	Standard Leadtime (Days)	List Price (USD)
	601-1	1/2" DIAMETER	10		1	208897	\$21.70
	601-2	3/4" DIAMETER	10	Sold in full	1	208934	\$27.20
	601-3	1" DIAMETER	10	case quantities	1	208941	\$31.10
	601-4	1-1/4" DIAMETER	10	only	1	208958	\$36.90
	601-5	1-1/2" DIAMETER	10		1	208965	\$40.60
	601-6	2" DIAMETER	10		1	208972	\$43.20

INSO-LINE STRAP HANGERS: 602 SERIES, 6" LENGTH

	602-1	1/2" DIAMETER	25	Sold in full	3	209016	\$82.50
	602-3	3/4" DIAMETER	25	case quantities	3	209115	\$84.80
	602-5	1" DIAMETER	25	only	3	209139	\$86.80
	602-7	1-1/4" DIAMETER	25		4	209153	\$90.00

INSO-LINE STRAP HANGERS: 602 SERIES, 12" LENGTH

	602-2	1/2" DIAMETER	25	Sold in full	4	209054	\$95.90
	602-4	3/4" DIAMETER	25	case quantities	4	209122	\$96.60
	602-6	1" DIAMETER	25	only	4	209146	\$99.10
	602-8	1-1/4" DIAMETER	25		4	209160	\$100.00

NATICK STRAP HANGERS: 603 SERIES, 6" LENGTH

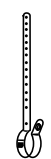
	603-1	1/2" DIAMETER	25	Sold in full	2	209474	\$46.30
	603-3	3/4" DIAMETER	25	case quantities	2	209641	\$46.80
	603-5	1" DIAMETER	25	only	3	209726	\$47.10
	603-7	1-1/4" DIAMETER	25		3	209900	\$47.60

NATICK STRAP HANGERS: 603 SERIES, 12" LENGTH

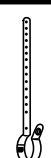
	603-2	1/2" DIAMETER	25	Sold in full	3	209542	\$57.60
	603-4	3/4" DIAMETER	25	case quantities	4	209719	\$58.00
	603-6	1" DIAMETER	25	only	4	209825	\$58.50
	603-8	1-1/4" DIAMETER	25		4	210012	\$58.80

GLIDE CLIPS: 604 SERIES

	604-1	1/2" DIAMETER	10	Sold in full	1	210234	\$23.70
	604-2	3/4" DIAMETER	10	case quantities	1	210241	\$25.50
	604-3	1" DIAMETER	10	only	1	210258	\$32.00
	604-4	1-1/4" DIAMETER	10		1	210265	\$36.20

VAN HANGERS: 606 SERIES

	606-2	1/2" DIAMETER	20	Sold in full	2	210494	\$36.90
	606-3	3/4" DIAMETER	20	case quantities	2	210500	\$39.40
	606-4	1" DIAMETER	20	only	2	210517	\$43.20

TUBE STRAPS: 608 SERIES

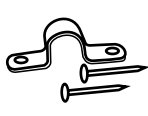
	608-4	1/2" DIAMETER	100	Sold in full	2	210760	\$22.40
	608-6	3/4" DIAMETER	50	case quantities	1	210777	\$14.90
	608-7	1" DIAMETER	50	only	2	210784	\$15.90
	608-8	1-1/4" DIAMETER	50		2	210791	\$21.00

Hardware: Strap Hangers, Glide Clips & Tube Straps include copper-clad nails.
 Tube Hangers & Van Hangers include copper-clad wood screws.

Warranty: 1-Year Limited

EX MODELS: EXTROL® INLINE BOILER SYSTEM EXPANSION TANKS
B

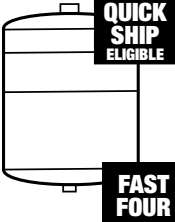
Model Number	Description	Volume (Gal)	Max Acceptance Volume (Gal)	Shipping Dimensions (In)			Shipping Weight (Lbs)	UPC 642031	Standard Leadtime (Days)	List Price (USD)	
				L	W	H					
 QUICK SHIP ELIGIBLE FAST FOUR	EX-15	101-1 MODEL #15	2.0	1.0	8	8	13	5	112743	5 QS	\$59.60
	EX-30	102-1 MODEL #30	4.4	2.5	11	11	15	9	113061	5 QS	\$73.10
	EX-60	103-1 MODEL #60	7.4	2.5	11	11	23	14	113221	5 QS	\$135.00
	EX-90	112-1 MODEL #90	14.0	11.3	15	15	21	23	115287	5 QS	\$224.00
EX-15-FF	101-1-FF FAST FOUR <i>4PC MASTER PACK</i>	2.0	1.0	17	17	13	20	639363	1 FF	\$238.00	
EX-30-FF	102-1-FF FAST FOUR <i>4PC MASTER PACK</i>	4.4	2.5	24	24	17	36	639394	1 FF	\$293.00	

SX MODELS: EXTROL VERTICAL BOILER SYSTEM EXPANSION TANKS
B

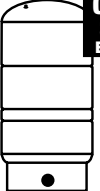
Model Number	Description	Volume (Gal)	Max Acceptance Volume (Gal)	Shipping Dimensions (In)			Shipping Weight (Lbs)	UPC 642031	Standard Leadtime (Days)	List Price (USD)	
				L	W	H					
 QUICK SHIP ELIGIBLE	SX-30V	118-27 STAND MODEL	14	11.3	15	15	24	25	118967	5 QS	\$265.00
	SX-40V	118-78 STAND MODEL	20	11.3	15	15	32	33	119896	5	\$282.00
	SX-60V	118-79 STAND MODEL	32	11.3	15	15	48	43	119902	5 QS	\$396.00
	SX-90V	118-153 STAND MODEL	44	34.0	22	22	36	69	118714	5 QS	\$721.00
	SX-110V	118-154 STAND MODEL	62	34.0	22	22	47	92	118721	5	\$849.00
	SX-130V	149-165 STAND MODEL	81	34.0	22	22	56	103	633583	5	\$875.00
	SX-160V	118-155 STAND MODEL	86	46.0	26	26	47	123	118738	5	\$902.00

EX PACKAGES: EXTROL COMBINATION KITS
B

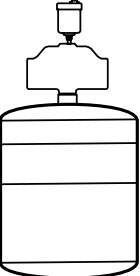
	EX-1500-100	105-1 EX-15 WITH 1" PURGER & VENT	2.0	1.0	8	8	15	10	113382	5	\$105.00
	EX-1500-125	105-2 EX-15 WITH 1-1/4" PURGER & VENT	2.0	1.0	8	8	15	10	113412	5	\$105.00
	EX-3000-100	106-1 EX-30 WITH 1" PURGER & VENT	4.4	2.5	11	11	19	14	113504	5	\$118.00
	EX-3000-125	106-2 EX-30 WITH 1-1/4" PURGER & VENT	4.4	2.5	11	11	19	14	113528	5	\$118.00

FT MODELS: FILL-TROL® TANKS AND AUTOMATIC FILL VALVES
B

Model Number	Description	Volume (Gal)	Max Acceptance Volume (Gal)	Shipping Dimensions (In)			Shipping Weight (Lbs)	UPC 642031	Standard Leadtime (Days)	List Price (USD)	
				L	W	H					
 QUICK SHIP ELIGIBLE	FT-109	109-1 FILL-TROL TANK & VALVE	2.0	1.0	8	8	15	6	114198	5 QS	\$110.00
	FT-110	110-1 FILL-TROL TANK & VALVE	4.4	2.5	11	11	17	10	114525	5 QS	\$127.00
	FT-111	111-1 FILL-TROL TANK & VALVE	7.4	2.5	11	11	25	15	114914	5	\$194.00
	FT-112	112-2 FILL-TROL TANK & VALVE	14.0	11.3	15	15	23	24	115300	5	\$256.00
	FT-15	109-133 FILL-TROL TANK ONLY	2.0	1.0	8	8	13	5	114310	5	\$72.90
	FT-30	110-002 FILL-TROL TANK ONLY	4.4	2.5	11	11	15	9	114488	5	\$88.20
	FT-109-15	109-15 FILL-TROL VALVE ONLY	-	-	-	-	-	1	370143	5	\$53.10

FT PACKAGES: FILL-TROL COMBINATION KITS
B

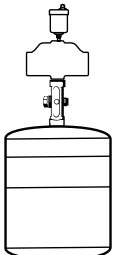
	FT-109-100	109-9 FT-109 WITH 1" PURGER & VENT	2.0	1.0	8	8	19	10	114433	5	\$150.00
	FT-109-125	109-10 FT-109 WITH 1-1/4" PURGER & VENT	2.0	1.0	8	8	19	10	114204	5	\$150.00
	FT-110-100	110-9 FT-110 WITH 1" PURGER & VENT	4.4	2.5	11	11	23	14	114600	5	\$167.00
	FT-110-125	110-10 FT-110 WITH 1-1/4" PURGER & VENT	4.4	2.5	11	11	23	14	114532	5	\$167.00
	FT-111-125	111-4 FT-111 WITH 1-1/4" PURGER & VENT	7.4	2.5	11	11	31	18	114938	5	\$231.00

RX MODELS: RADIANT EXTROL® HEATING SYSTEM EXPANSION TANKS B

Model Number	Description	Volume (Gal)	Max Acceptance Volume (Gal)	Shipping Dimensions (In)			Shipping Weight (Lbs)	UPC 642031	Standard Leadtime (Days)	List Price (USD)
				L	W	H				
 RX-15	140-705 INLINE MOUNTING	2.0	0.9	8	8	13	5	413291	5	\$82.20
RX-30	141-305 INLINE MOUNTING	4.4	3.2	11	11	15	9	413307	5	\$101.00
RX-60	143-381 VERTICAL STAND	10.3	10.3	15	15	19	23	600035	5	\$227.00

SE MODELS: CLOSED-LOOP SOLAR EXTROL® EXPANSION TANKS B

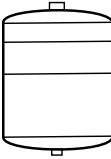
 SE-15	104-001 INLINE MOUNTING	2.0	1.0	8	8	13	5	633880	10	\$65.00
SE-30	104-002 INLINE MOUNTING	4.4	2.5	11	11	15	9	633897	10	\$79.50
SE-60	104-003 INLINE MOUNTING	7.4	2.5	11	11	23	14	633903	10	\$178.00

Pallet Quantity: EX-15: 75, EX-30: 48, EX-60: 32, EX-90: 18, Combination Packages: Same as base model
 SX-30V & SX-40V: 18, SX-60V: 9, SX-90V through SX-110V: 4, RX-15: 75, RX-30: 48, RX-60: 18
 SE-15: 75, SE-30: 48, SE-60: 32

Connection: Steel: EX-15 through EX-90: 1/2" NPTM, SX-30V through SX-60V: 1" NPTF, SX-90V through SX-160V: 1-1/4" NPTF, SE-15 through SE-60: 1/2" NPTM
 Brass: FT Models: 1/2" NPTF
 Stainless Steel: RX-15 through RX-30: 1/2" NPTM, RX-60: 3/4" NPTF

Warranty: EX, FT, RX & SE Models: 5-Year Limited, SX Models: 1-Year Limited

Maximum Operating Temp: Extrol, Fill-Trol: 240° F; Radiant Extrol: 200° F, Solar Extrol: Intermittant 250° F, Continuous 225° F
Maximum Working Pressure: 100 PSI

Air Purgers, Vents & Valves

AIR VENTS H

Model Number	Description	Shipping Dimensions (In)			Shipping Weight (Lbs)	UPC 642031	Standard Leadtime (Days)	List Price (USD)
		L	W	H				
 700-QC	700-QC FLOAT VENT, 1/8" QUICK-CHANGE	2	2	4	0.5	591982	5	\$13.20
701-C	701-30 FLOAT VENT, 1/4" CONNECTION	2	2	4	0.5	389473	5	\$13.20
700-C	700-30 FLOAT VENT, 1/8" CONNECTION	2	2	4	0.5	389466	5	\$12.00

AIR PURGERS C

 443-1	CAST AIR PURGER 1"	6	3	4	4	193117	5	\$25.00
444-1	CAST AIR PURGER 1-1/4"	6	3	4	4	193148	5	\$25.00
445-1	CAST AIR PURGER 1-1/2"	8	4	5	9	193186	5	\$57.10
446-1	CAST AIR PURGER 2"	8	4	5	10	193223	5	\$63.20
447-1	CAST AIR PURGER 2-1/2"	10	5	6	19	193254	5	\$143.00
448-1	CAST AIR PURGER 3"	10	5	6	20	193261	5	\$177.00

TANK SERVICE CHECK VALVE C

 140-470	SERVICE CHECK, 1/2" QUICK CHANGE	1	1	1	0.1	603487	5	\$12.80
---	----------------------------------	---	---	---	-----	--------	---	---------

MIXING VALVES C

 420-1	1/2" DOMESTIC WATER MIXING VALVE 110-170F	2	2	4	1	190819	5	\$86.20
421-1	3/4" DOMESTIC WATER MIXING VALVE 110-170F	2	2	4	1	190888	5	\$95.30
420-6	MIXING VALVE REPLACEMENT CARTRIDGE	-	-	-	1	190826	5	\$26.30

Case Qty: Air Vents: 24, 443 & 444 Purgers:12
Purges Vent Tpng: 443 through 445: 1/8" NPT, 446: 1/2" NPT, 447 & 448: 3/4" NPT
Purges Exp Tpng: 443 through 448: 1/2" NPT
Warranty: 1-Year Limited

HYDROMAX® INDIRECT-FIRED WATER HEATERS

G

QUICK SHIP ELIGIBLE

Model Number	Description	Coil	Control	Color	Volume (Gal)	Shipping Dimensions (In)			Shipping Weight (Lbs)	UPC 642031	Standard Leadtime (Days)	List Price (USD)
						L	W	H				
HM-41Z	2783Z01-8	140MBH TOP	MECHANICAL	BLACK	41	22	22	55	124	653000	5 QS	\$1,634.00
HM-41ZDW	2800Z01-8	140MBH TOP	MECHANICAL DBL WALL	BLACK	41	22	22	55	134	659842	5	\$2,197.00
HM-41L	2783L01-8	140MBH TOP	ENER-G-NET™	BLACK	41	22	22	55	124	654168	5	\$1,746.00
HM-41LDW	2800L01-8	140MBH TOP	ENER-G-NET DBL WALL	BLACK	41	22	22	55	134	659859	5	\$2,309.00
HM-80Z	2782Z01-8	140MBH TOP	MECHANICAL	BLACK	80	26	26	62	180	654007	5	\$2,207.00
HM-80ZDW	2801Z01-8	140MBH TOP	MECHANICAL DBL WALL	BLACK	80	26	26	62	190	659835	5	\$2,770.00
HM-80L	2782L01-8	140MBH TOP	ENER-G-NET	BLACK	80	26	26	62	180	654199	5	\$2,321.00
HM-80LDW	2801L01-8	140MBH TOP	ENER-G-NET DBL WALL	BLACK	80	26	26	62	190	659828	5	\$2,884.00

HM MODELS

BOILERMATE® INDIRECT-FIRED WATER HEATERS

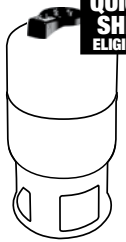
G

QUICK SHIP ELIGIBLE

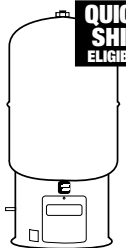
CH-41Z-B	2703Z01-6	100MBH TOP	MECHANICAL	BLUE	41	22	22	48	124	632951	10 QS	\$1,482.00
CH-41Z-R	2703Z01-1	100MBH TOP	MECHANICAL	RED	41	22	22	48	124	632937	10	\$1,482.00
CH-41Z-G	2703Z01-5	100MBH TOP	MECHANICAL	GRAY	41	22	22	48	124	630773	10	\$1,482.00
CH-41ZDW-B	2703DW01-6	100MBH TOP DBL WALL	MECHANICAL	BLUE	41	22	22	48	134	646040	10	\$1,858.00
CH-41ZDW-R	2703DW01-1	100MBH TOP DBL WALL	MECHANICAL	RED	41	22	22	48	134	646033	10	\$1,858.00
CH-41ZDW-G	2703DW01-5	100MBH TOP DBL WALL	MECHANICAL	GRAY	41	22	22	48	134	646026	10	\$1,858.00
CH-41ZCT-B	2703Z02-6	100MBH TOP	CONSTANT TEMP	BLUE	41	22	22	51	127	637376	15	\$1,912.00
CH-41ZCT-R	2703Z02-1	100MBH TOP	CONSTANT TEMP	RED	41	22	22	51	127	638243	15	\$1,912.00
CH-41ZCT-G	2703Z02-5	100MBH TOP	CONSTANT TEMP	GRAY	41	22	22	51	127	638236	15	\$1,912.00

CH MODELS

QUICK SHIP ELIGIBLE

CH-80Z-B	2702Z01-6	100MBH TOP	MECHANICAL	BLUE	80	26	26	49	180	636324	10	\$2,112.00
CH-80Z-R	2702Z01-1	100MBH TOP	MECHANICAL	RED	80	26	26	49	180	636300	10	\$2,112.00
CH-80Z-G	2702Z01-5	100MBH TOP	MECHANICAL	GRAY	80	26	26	49	180	635969	10	\$2,112.00
CH-80ZDW-B	2702DW01-6	100MBH TOP DBL WALL	MECHANICAL	BLUE	80	26	26	49	190	646071	10	\$2,645.00
CH-80ZDW-R	2702DW01-1	100MBH TOP DBL WALL	MECHANICAL	RED	80	26	26	49	190	646057	10	\$2,645.00
CH-80ZDW-G	2702DW01-5	100MBH TOP DBL WALL	MECHANICAL	GRAY	80	26	26	49	190	646064	10	\$2,645.00
WH-41Z-B	2704Z37-6	100MBH BOTTOM	MECHANICAL	BLUE	41	22	22	48	134	600998	10 QS	\$1,482.00
WH-41Z-R	2704Z37-1	100MBH BOTTOM	MECHANICAL	RED	41	22	22	48	134	577252	10	\$1,482.00
WH-41Z-G	2704Z81	100MBH BOTTOM	MECHANICAL	GRAY	41	22	22	48	134	557469	10	\$1,482.00
WH-41L-B	2704E67-6	100MBH BOTTOM	DIGITAL	BLUE	41	22	22	48	134	929623	10 QS	\$1,609.00
WH-41L-R	2704E67-1	100MBH BOTTOM	DIGITAL	RED	41	22	22	48	134	577269	10	\$1,609.00
WH-41L-G	2704E80	100MBH BOTTOM	DIGITAL	GRAY	41	22	22	48	134	557452	10	\$1,609.00
WH-41ZDW-B	2704Z1014	100MBH BOTTOM DBL WALL	MECHANICAL	BLUE	41	22	22	48	144	629630	10	\$1,858.00
WH-41ZDW-G	2704Z86	100MBH BOTTOM DBL WALL	MECHANICAL	GRAY	41	22	22	48	144	576101	10	\$1,858.00
WH-41LDW-B	2704E1015	100MBH BOTTOM DBL WALL	DIGITAL	BLUE	41	22	22	48	144	629647	10	\$1,988.00
WH-41LDW-G	2704E87	100MBH BOTTOM DBL WALL	DIGITAL	GRAY	41	22	22	48	144	576118	10	\$1,988.00

WH MODELS

HOT WATER MAKER REPLACEMENT PARTS

I
CONTROLS

2704-093	AQUASTAT: RESIDENTIAL 150F, ALL EXC WH-10	MECHANICAL	390028	1	\$122.00
2775-454	AQUASTAT: COMMERCIAL 180F, ALL EXC WH-10	MECHANICAL	519658	1	\$164.00
2770-133	AQUASTAT: 150F, WH-10	MECHANICAL	343475	1	\$122.00
940R101	DIGITAL CONTROL REPLACEMENT & UPGRADE, WH, TD & WHS	DIGITAL	654144	1	\$294.00
940R2	ENER-G-NET DIGITAL CONTROL ONLY	DIGITAL	654069	1	\$290.00
2704-259	DIGITAL TEMPERATURE SENSOR ONLY (THERMISTOR)	DIGITAL	432650	1	\$37.90
2704-392	AQUASTAT RETROFIT KIT, WH	MECHANICAL	466846	1	\$244.00
2704-487	AQUASTAT RETROFIT KIT W/RELAY, WH	MECHANICAL	611888	1	\$279.00
2775-455	AQUASTAT RETROFIT KIT, WHS	MECHANICAL	519726	1	\$244.00
2775-768	AQUASTAT RETROFIT KIT W/RELAY, WHS	MECHANICAL	611857	1	\$279.00
2704-529	UNIVERSAL 10K DIGITAL TEMP SENSOR KIT	DIGITAL	651044	1	\$39.70

HEAT EXCHANGER COILS

2700-5000	WH MODELS (ALL EXCEPT WH-7C)	534095	1	\$1,062.00
2700-5001	WH-7C & WHS-C COMMERCIAL MODELS	534101	1	\$1,283.00
2700-5002	WH-DW DBL-WALL MODELS (EXCEPT WH-7C)	534118	1	\$1,780.00
2700-5003	WH-7CDW & WHS-CDW COM. DBL. WALL MDLS	534125	1	\$2,269.00
2700-5005	TD-41 MODELS (EXCEPT DW)	604002	1	\$1,246.00
2700-5006	TD-41DW DOUBLE-WALL MODELS	604033	1	\$2,228.00
2700-5008	TD-80 MODELS	604026	1	\$1,289.00
2703R003	CH-41 MODELS	641762	1	\$750.00
2702R002	CH-80 MODELS	659934	1	\$785.00
2702R007	CH-80 DW DOUBLE-WALL MODELS	686954	1	\$1,504.00
2775-82	WHS MODELS (EXCEPT C & DW)	534378	1	\$1,083.00
2775-83	WHS-DW RESIDENTIAL MODELS	534385	1	\$1,801.00
2775-84	WHS-DW COMMERCIAL MODELS	534392	1	\$2,346.00
2713R002	HM-41 MODELS	659958	1	\$958.00
2712R002	HM-80 MODELS	659941	1	\$999.00
2801R002	HM-80 DW DOUBLE-WALL MODELS	686947	1	\$1,717.00

MISC PARTS

2700-924	AQUASTAT DRY WELL	166357	1	\$58.30
2500-218	HEAT EXCHANGER COIL GASKET, 8 BOLT	160768	1	\$7.60
2500-178	WH TOP OUTLET O-RING	160690	1	\$0.95
2700-635	WH TOP OUTLET UNION TEE PACKAGE	164438	1	\$77.90
2703R001	DIP TUBE, CH-41	673503	1	\$11.40
2702R001	DIP TUBE, CH-80	677389	1	\$14.30
9340R160	DRAIN VALVE ASSEMBLY, ALL CH & HM	671271	1	\$71.40
2700R1106	T&P RELIEF VALVE, RESIDENTIAL	643896	1	\$34.20
2704R512	TOP COVER HALF, HM-41 & HM-80	677372	1	\$37.00
2783R0001	HEAT TRAP, ALL HM	677365	1	\$23.30
2783R0004	T&P BLOWDOWN TUBE: HM-41	677341	1	\$41.40
2782R0002	T&P BLOWDOWN TUBE: HM-80	677358	1	\$41.60

PREMIER™ INDIRECT-FIRED WATER HEATERS

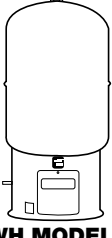
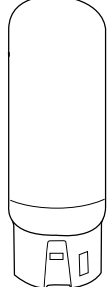
Model Number	Description	Coil	Control	Material	Volume (Gal)	Shipping Dimensions (In)			Shipping Weight (Lbs)	UPC 642031	Standard Leadtime (Days)	List Price (USD)	
						L	W	H					
 WH MODELS	WH-7C	2704E76	240MBH BOTTOM	DIGITAL	180F Poly	41	22	22	48	144	557414	10	\$2,971.00
	WH-7ZC	2704Z91	240MBH BOTTOM	MECHANICAL	180F Poly	41	22	22	48	144	582072	10	\$2,847.00
	WH-7CDW	2704E75	240MBH BOTTOM DBL WALL	DIGITAL	180F Poly	41	22	22	48	154	557407	10	\$3,590.00
 WHS & DC MODELS	WHS-60Z	2775S5009	140MBH BOTTOM	MECHANICAL	Stainless	60	26	26	54	160	557506	10	\$3,455.00
	WHS-60L	2775S5007	140MBH BOTTOM	DIGITAL	Stainless	60	26	26	54	160	557483	10	\$3,710.00
	WHS-60ZDW	2775S5010	140MBH BOTTOM DBL WALL	MECHANICAL	Stainless	60	26	26	54	170	557513	10	\$4,010.00
	WHS-60LDW	2775S5008	140MBH BOTTOM DBL WALL	DIGITAL	Stainless	60	26	26	54	170	557490	10	\$4,223.00
	WHS-60ZC	2775S5027	240MBH BOTTOM	MECHANICAL	Stainless	60	26	26	54	170	575753	10	\$3,794.00
	WHS-60ZCDW	2775S5011	240MBH BOTTOM DBL WALL	MECHANICAL	Stainless	60	26	26	54	170	557520	10	\$4,660.00
	WHS-80Z	2775S5014	140MBH BOTTOM	MECHANICAL	Stainless	80	26	26	66	170	557551	10	\$4,128.00
	WHS-80L	2775S5012	140MBH BOTTOM	DIGITAL	Stainless	80	26	26	66	170	557537	10	\$4,366.00
	WHS-80ZDW	2775S5015	140MBH BOTTOM DBL WALL	MECHANICAL	Stainless	80	26	26	66	180	557568	10	\$4,451.00
	WHS-80LDW	2775S5013	140MBH BOTTOM DBL WALL	DIGITAL	Stainless	80	26	26	66	180	557544	10	\$4,688.00
	WHS-80ZC	2775S5026	240MBH BOTTOM	MECHANICAL	Stainless	80	26	26	66	180	575777	10	\$4,344.00
	WHS-80ZCDW	2775S5016	240MBH BOTTOM DBL WALL	MECHANICAL	Stainless	80	26	26	66	180	557575	10	\$5,100.00
	DC-80	2775S5029	DUAL HEAT EXCHANGERS	MECHANICAL	Stainless	80	26	26	66	190	584151	10	\$5,080.00
	DC-80DW	2775S5030	DUAL DBL WALL EXCHANGERS	MECHANICAL	Stainless	80	26	26	66	200	584182	10	\$5,730.00
	WHS-120Z	2775S5020	140MBH BOTTOM	MECHANICAL	Stainless	120	30	30	71	200	557605	10	\$5,520.00
WHS-120L	2775S5019	140MBH BOTTOM	DIGITAL	Stainless	120	30	30	71	200	557599	10	\$5,730.00	
WHS-120ZC	2775S5025	240MBH BOTTOM	MECHANICAL	Stainless	120	30	30	71	200	575791	10	\$5,800.00	
WHS-120ZCDW	2775S5021	240MBH BOTTOM DBL WALL	MECHANICAL	Stainless	120	30	30	71	210	557612	10	\$6,450.00	
DC-120	2775S5031	DUAL HEAT EXCHANGERS	MECHANICAL	Stainless	120	30	30	71	220	584212	10	\$6,520.00	
DC-120DW	2775S5032	DUAL DBL WALL EXCHANGERS	MECHANICAL	Stainless	120	30	30	71	230	584243	10	\$7,360.00	

PREMIER HOT WATER STORAGE TANKS

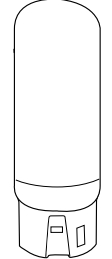
Model Number	Description	Volume (Gal)	Shipping Dimensions (In)			Shipping Weight (Lbs)	UPC 642031	Standard Leadtime (Days)	List Price (USD)	
			L	W	H					
 S MODELS	S-41	2704-71	41	22	22	54	120	552419	10	\$1,221.00
	S-41L	2704-83 LESS AQUASTAT	41	22	22	54	120	566591	10	\$1,126.00
	S-80	2775-5001	80	26	26	66	156	552426	10	\$2,995.00
	S-80L	2775-5023 LESS AQUASTAT	80	26	26	66	156	571144	10	\$2,896.00
	S-120	2775-5002	120	30	30	71	196	552433	10	\$4,283.00
	S-120L	2775-5024 LESS AQUASTAT	120	30	30	71	196	571151	10	\$4,183.00



Pallet Quantity: All Models: 4
Warranty: HM Models: 7-Years with Limited Lifetime upgrade option in carton
 CH & WH Models: 6-Years with Limited Lifetime upgrade option in carton
 WHS, DC & S Models: 10-Year Limited (Residential), 5-Year Limited (Commercial)
Hardware: All models include T&P relief and drain valves

APPLICATIONS & ORDERING

- For use in non-potable closed hydronic and chilled water systems.
- Fixed diaphragm construction.
- Available in Horizontal and Vertical configurations.
- Constructed to ASME Section VIII, Division 1.
- Maximum Operating Temperature: 240° F.

How to Order: Specify Model & Options

AX-80-125SGR

- Step 1: Select Base Model Number
 Step 2: Choose Pressure Rating
 Step 3: Specify Sight Glass Option (or leave blank)
 Step 4: Specify Restraint Option (or leave blank)

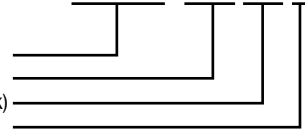

AX-80 (Horizontal) 125 PSI Rating with Sight Glass & Restraints

AX MODELS: HORIZONTAL DIAPHRAGM TYPE, ASME

J

TECHNICAL DATA

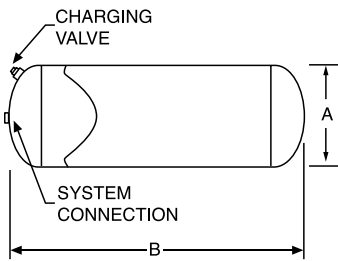

AX-15 THROUGH AX-240

Base Model Number	Volume (Gal)	Max Acceptance Volume (Gal)	A Diameter (In)	B Length (In)	Shipping Weight (Lbs)				
					125 PSI	150 PSI	175 PSI	250 PSI	300 PSI
AX-15	8.0	2.4	12	19	37	39	48	55	59
AX-20	10.9	2.4	12	26	46	48	60	69	74
AX-40	21.7	11.3	16	29	74	76	96	111	118
AX-60	33.6	11.3	16	43	96	120	125	144	154
AX-80	44.4	22.6	24	29	153	160	200	230	245
AX-100	55.7	22.6	24	33	174	180	227	261	279
AX-120	68.0	34.0	24	41	204	245	266	306	327
AX-144	77.0	34.0	24	46	218	250	285	327	350
AX-180	90.0	34.0	24	54	232	265	301	348	372
AX-200	110.0	34.0	24	64	269	320	350	404	430
AX-240	132.0	46.0	30	51	401	403	522	602	642
AX-260	159.0	56.0	30	62	455	460	572	683	728
AX-280	211.0	84.0	30	80	580	600	755	870	930

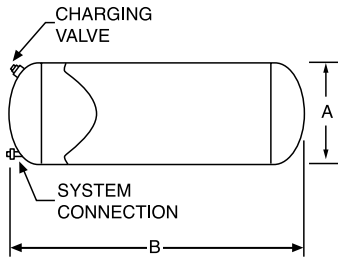

AX-260 & AX-280

PRICING: ASME MODELS

Base Model Number	Part No. / List Price (USD)				
	125 PSI	150 PSI	175 PSI	250 PSI	300 PSI
AX-15	117-0015 / \$1,563	117-459 / \$1,719	\$1,890	117-622 / \$2,080	\$2,289
AX-20	117-0020 / \$1,588	117-462 / \$1,747	\$1,921	\$2,114	\$2,326
AX-40	117-0040 / \$2,233	117-465 / \$2,454	117-556 / \$2,701	\$2,972	\$3,268
AX-60	117-0060 / \$2,452	117-468 / \$2,699	117-554 / \$2,969	\$3,266	\$3,594
AX-80	117-80 / \$3,113	117-525 / \$3,425	\$3,767	\$4,144	\$4,559
AX-100	117-100 / \$3,219	117-476 / \$3,540	\$3,895	\$4,285	\$4,713
AX-120	117-120 / \$3,398	117-481 / \$3,739	117-553 / \$4,010	\$4,523	\$4,953
AX-144	117-144 / \$3,712	117-484 / \$4,083	\$4,492	\$4,942	\$5,430
AX-180	117-180 / \$3,920	117-487 / \$4,312	\$4,742	\$5,210	\$5,750
AX-200	117-200 / \$4,187	117-490 / \$4,605	117-449 / \$5,070	\$5,570	\$6,130
AX-240	117-408 / \$4,795	117-493 / \$5,270	\$5,800	\$6,390	\$7,020
AX-260	117-420 / \$6,560	117-496 / \$7,210	\$7,930	\$8,730	\$9,600
AX-280	117-430 / \$7,960	117-499 / \$8,760	\$8,970	\$10,575	\$11,675

Additional Options: Add to Base Model List Price
Sight Glass (SG): \$320
Restraints (Saddles) (R): AX-15 & 20: \$142, AX-40 & 60: \$218, AX-80 through 200: \$328, AX-240 through 280: \$437

Standard Leadtime: 125 & 150 PSI: 10 Days, 175 PSI: 30 Days, 250 & 300 PSI: 40 Days
Connection: Malleable Iron: AX-15 through AX-60: 1/2", AX-80 through AX-240: 1", AX-260 & AX-280: 1-1/4"
 AX-15 through AX-100: NPTF, Center
 AX-120 through AX-240: NPTM, Center
 AX-260 & AX-280: NPTM, Offset
Factory Precharge: All models: 12 PSI
Warranty: 1-Year Limited

COMMERCIAL PRODUCTS

APPLICATIONS & ORDERING

- For use in non-potable closed hydronic and chilled water systems.
- Fixed diaphragm construction.
- Available in Horizontal and Vertical configurations.
- Constructed to ASME Section VIII, Division 1.
- Maximum Operating Temperature: 240° F.

How to Order: Specify Model & Options

AX-120V-150

- Step 1: Select Base Model Number
 Step 2: Choose Pressure Rating
 Step 3: Specify Sight Glass Option (or leave blank)
 Step 4: Specify Restraint Option (or leave blank)

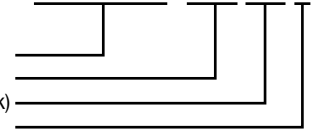

AX-120V (Vertical) 150 PSI Rating (No Sight Glass and Restraints)

AX-V MODELS: VERTICAL DIAPHRAGM TYPE, ASME

J

TECHNICAL DATA

Base Model Number	Volume (Gal)	Max Acceptance Volume (Gal)	A Diameter (In)	B Height (In)	Shipping Weight (Lbs)				
					125 PSI	150 PSI	175 PSI	250 PSI	300 PSI
AX-15V	8.0	2.4	12	20	39	41	49	59	62
AX-20V	10.9	2.4	12	27	47	49	61	71	75
AX-40V	21.7	11.3	16	30	76	80	99	114	122
AX-60V	33.6	11.3	16	45	98	103	127	147	157
AX-80V	44.4	22.6	24	29	155	167	201	233	248
AX-100V	55.7	22.6	24	34	176	187	229	264	282
AX-120V	68.0	34.0	24	47	214	255	278	321	342
AX-144V	77.0	34.0	24	52	230	267	299	345	368
AX-180V	90.0	34.0	24	60	271	275	352	407	434
AX-200V	110.0	34.0	24	66	290	358	377	435	464
AX-240V	132.0	46.0	30	58	401	403	521	602	642
AX-260V	159.0	56.0	30	65	460	467	598	690	736
AX-280V	211.0	84.0	30	82	590	605	767	885	945

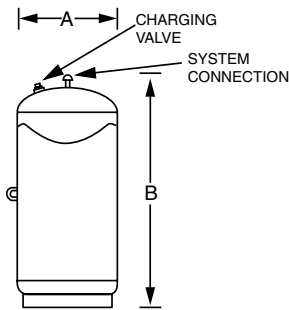

AX-15V THROUGH AX-100V

PRICING: ASME MODELS

Base Model Number	Part No. / List Price (USD)				
	125 PSI	150 PSI	175 PSI	250 PSI	300 PSI
AX-15V	117-401 / \$1,564	117-461 / \$1,720	117-454 / \$1,891	117-551 / \$2,081	117-586 / \$2,290
AX-20V	117-402 / \$1,588	117-464 / \$1,747	117-452 / \$1,921	117-573 / \$2,114	\$2,326
AX-40V	117-403 / \$2,233	117-467 / \$2,454	117-453 / \$2,701	\$2,972	117-625 / \$3,268
AX-60V	117-0062 / \$2,452	117-470 / \$2,699	117-0559 / \$2,969	117-591 / \$3,266	\$3,594
AX-80V	117-81 / \$3,130	117-474 / \$3,443	117-588 / \$3,787	117-569 / \$4,166	\$4,584
AX-100V	117-101 / \$3,226	117-479 / \$3,548	\$3,903	117-558 / \$4,293	117-550 / \$4,725
AX-120V	117-121 / \$3,877	117-483 / \$4,266	117-620 / \$4,693	117-593 / \$5,160	\$5,690
AX-144V	117-145 / \$4,131	117-486 / \$4,545	\$4,999	117-102 / \$5,510	117-589 / \$6,060
AX-180V	117-181 / \$4,689	117-489 / \$5,160	117-565 / \$5,690	\$6,240	\$6,860
AX-200V	117-201 / \$4,801	117-492 / \$5,280	117-585 / \$5,810	117-557 / \$6,400	\$7,030
AX-240V	117-281 / \$5,520	117-495 / \$6,070	\$6,670	\$7,340	117-598 / \$8,080
AX-260V	117-421 / \$6,670	117-498 / \$7,340	\$8,090	\$8,890	\$9,790
AX-280V	117-431 / \$8,230	117-501 / \$9,050	117-580 / \$9,950	117-572 / \$10,950	\$12,050

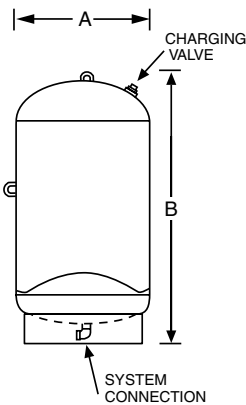

AX-120V THROUGH AX-240V

- Additional Options:** Add to Base Model List Price
Sight Glass (SG): \$320
Seismic Restraints (R): \$225

- Standard Leadtime:** 125 & 150 PSI: 10 Days, 175 PSI: 30 Days, 250 & 300 PSI: 40 Days
Connection (NPT): Malleable Iron: AX-15V through AX-60V: 1/2", AX-80V through AX-240V: 1", AX-260V & AX-280V: 1-1/4"
 AX-15V through AX-100V: NPTF, Center
 AX-120V through AX-240V: NPTF, Bottom
 AX-260V & AX-280V: NPTM, Offset

- Factory Precharge:** All models: 12 PSI
Warranty: 1-Year Limited

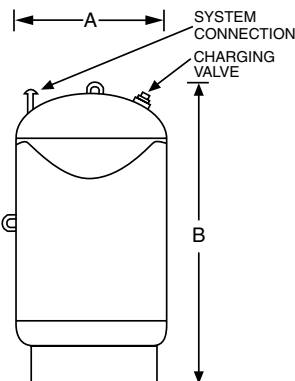

AX-260V & AX-280V

APPLICATIONS & ORDERING

- For use in non-potable closed hydronic and chilled water systems.
- Replaceable bladder construction.
- Available in Full Acceptance versions.
- Constructed to ASME Section VIII, Division 1.
- Maximum Operating Temperature: 240° F.

How to Order: Specify Model & Options

800-L-175SGR

- Step 1: Select Base Model Number
 Step 2: Choose Pressure Rating
 Step 3: Specify Sight Glass Option (or leave blank)
 Step 4: Specify Restraint Option (or leave blank)

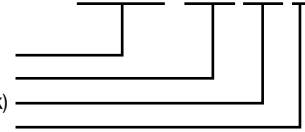

800-L 175 PSI Rating with Sight Glass & Restraints

L MODELS: FULL ACCEPTANCE BLADDER, TOP CONNECTION, ASME

J

TECHNICAL DATA

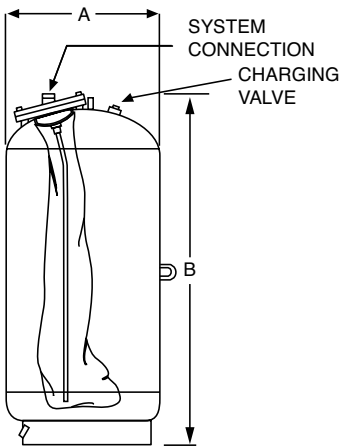

Base Model Number	Volume (Gal)	Max Acceptance Volume (Gal)	A Diameter (In)	B Height (In)	Shipping Weight (Lbs)				
					125 PSI	150 PSI	175 PSI	250 PSI	300 PSI
200-L	53	53	24	38	190	205	250	290	297
300-L	80	80	24	52	230	292	320	385	372
400-L	106	106	24	66	275	343	375	465	595
500-L	132	132	24	79	311	372	435	545	750
600-L	158	158	30	64	439	510	595	720	810
800-L	211	211	30	82	543	565	620	905	950
1000-L	264	264	36	74	609	750	750	1,015	1,065
1200-L	317	317	36	86	700	860	860	1,175	1,235
1400-L	370	370	36	98	783	970	970	1,335	1,400
1600-L	422	422	48	69	1,106	1,425	1,615	1,916	2,015
2000-L	528	528	48	84	1,284	1,675	2,386	2,410	2,651
2500-L	660	660	48	101	1,544	1,945	2,411	2,585	2,715
3000-L	792	792	48	118	1,719	2,225	2,500	2,950	3,100
3500-L	925	925	54	111	2,187	2,375	2,620	3,660	3,780
4000-L	1,057	1,057	54	125	2,352	2,640	3,000	4,080	4,285
5000-L	1,321	1,321	60	128	2,450	3,740	4,100	4,200	5,200
7500-L	1,980	1,980	72	127	4,000	4,300	4,500	5,550	6,750
10000-L	2,640	2,640	72	159	4,900	5,300	5,500	6,800	11,000
15000-L	3,963	3,963	72	233	6,000	7,600	7,900	9,800	12,500

200-L THROUGH 15000-L

PRICING: ASME MODELS

Base Model Number	Part No. / List Price (USD)				
	125 PSI	150 PSI	175 PSI	250 PSI	300 PSI
200-L	191-2 / \$5,080	117-509 / \$5,890	191-19 / \$6,720	191-18 / \$7,730	191-42 / \$8,880
300-L	192-2 / \$5,430	117-510 / \$6,250	192-20 / \$7,190	192-19 / \$8,260	192-39 / \$9,510
400-L	193-2 / \$5,780	117-511 / \$6,640	193-20 / \$7,650	193-19 / \$8,800	193-41 / \$10,125
500-L	194-2 / \$6,070	117-512 / \$6,970	194-19 / \$8,020	194-18 / \$9,220	194-37 / \$10,600
600-L	174-2 / \$8,550	117-513 / \$9,850	174-22 / \$11,325	174-23 / \$13,025	194-39 / \$14,975
800-L	175-2 / \$9,290	117-514 / \$10,675	175-22 / \$12,300	175-23 / \$14,125	175-37 / \$16,250
1000-L	176-2 / \$10,675	117-515 / \$12,325	176-22 / \$14,175	176-23 / \$16,275	176-35 / \$18,725
1200-L	177-2 / \$11,400	117-516 / \$13,100	177-22 / \$15,100	177-16 / \$17,350	177-33 / \$19,950
1400-L	178-2 / \$12,200	117-517 / \$14,025	178-22 / \$16,150	178-23 / \$18,550	178-34 / \$21,325
1600-L	179-2 / \$17,550	117-518 / \$20,225	179-22 / \$23,225	179-23 / \$26,700	179-34 / \$30,750
2000-L	180-2 / \$19,050	117-519 / \$21,900	180-22 / \$25,150	180-23 / \$28,950	180-74 / \$33,300
2500-L	180-33 / \$21,975	117-520 / \$25,350	180-40 / \$29,075	180-43 / \$33,450	180-76 / \$38,425
3000-L	180-34 / \$27,925	117-521 / \$32,050	180-39 / \$36,900	180-44 / \$42,425	180-64 / \$48,775
3500-L	189-1 / \$33,850	117-522 / \$38,950	180-41 / \$44,775	180-45 / \$51,500	180-78 / \$59,300
4000-L	189-2 / \$39,400	117-523 / \$46,425	180-42 / \$52,050	180-46 / \$59,950	180-79 / \$68,950
5000-L	189-3 / \$52,000	117-940 / \$59,850	180-65 / \$68,750	180-66 / \$79,100	180-129 / \$90,950
7500-L	189-24 / \$91,800	117-473 / \$105,600	180-55 / \$121,300	189-42 / \$139,600	180-81 / \$160,600
10000-L	180-137 / \$105,200	117-941 / \$120,900	180-57 / \$139,100	180-58 / \$160,000	180-82 / \$183,900
15000-L	189-10 / \$139,800	117-475 / \$160,700	180-59 / \$184,900	180-60 / \$212,500	180-83 / \$244,400

Additional Options: Add to Base Model List Price
Sight Glass (SG): \$320
Seismic Restraints (R): \$225

Standard Leadtime: 200-L through 4000-L: 125 & 150 PSI: 10 Days, 175 PSI: 30 Days, 250 & 300 PSI: 40 Days
 5000-L: 125 & 150 PSI: 20 Days, 175 PSI: 40 Days, 250 & 300 PSI: 60 Days,
 7500-L through 15000-L: All pressures: 60 Days

Connection (NPTF): Malleable Iron: 200-L through 500-L: 1", 600-L through 2000-L: 1-1/2",
 2500-L through 5000-L: 2", 7500-L through 15000-L: 3"

Factory Precharge: All models: 12 PSI
Warranty: 1-Year Limited

APPLICATIONS & ORDERING

- For use in non-potable closed hydronic and chilled water systems.
- Replaceable bladder construction.
- Available in Partial Acceptance versions.
- Constructed to ASME Section VIII, Division 1.
- Maximum Operating Temperature: 240° F.

How to Order: Specify Model & Options

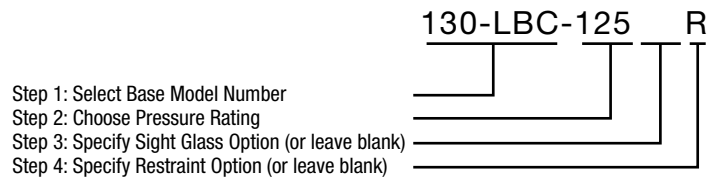

130-LBC 125 PSI Rating with Restraints (No Sight Glass)

LBC MODELS: PARTIAL ACCEPTANCE BLADDER, BOTTOM CONNECTION, ASME

J

TECHNICAL DATA

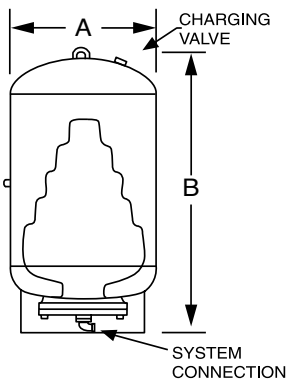

Base Model Number	Volume (Gal)	Max Acceptance Volume (Gal)	A Diameter (In)	B Height (In)	Shipping Weight (Lbs)				
					125 PSI	150 PSI	175 PSI	250 PSI	300 PSI
35-LBC	10	10	10	37	67	76	80	94	100
50-LBC	13	11	12	37	76	78	91	106	114
85-LBC	22	11	16	35	92	95	110	129	138
100-LBC	26	11	16	39	99	102	119	138	150
130-LBC	34	27	20	35	135	140	162	189	202
165-LBC	44	27	20	40	149	153	178	214	225
200-LBC	53	27	24	41	195	205	234	273	293
300-LBC	80	27	24	56	233	254	280	326	350
400-LBC	106	53	24	69	274	308	329	383	411
500-LBC	132	53	24	83	310	352	372	434	465
600-LBC	158	53	30	67	438	442	525	613	657

PRICING: ASME MODELS

Base Model Number	Part No. / List Price (USD)				
	125 PSI	150 PSI	175 PSI	250 PSI	300 PSI
35-LBC	165-5 / \$3,623	165-10 / \$4,166	\$4,793	\$5,520	\$6,330
50-LBC	166-5 / \$3,663	166-10 / \$4,211	\$4,733	166-18 / \$5,570	166-1 / \$6,410
85-LBC	167-4 / \$3,714	167-10 / \$4,271	\$4,912	\$5,650	167-18 / \$6,500
100-LBC	168-4 / \$3,769	168-10 / \$4,335	\$4,985	\$5,740	\$6,600
130-LBC	169-4 / \$3,820	117-502 / \$4,393	\$5,050	\$5,810	\$6,680
165-LBC	171-15 / \$3,915	117-503 / \$4,503	117-601 / \$5,180	\$5,950	\$6,850
200-LBC	191-33 / \$3,979	117-504 / \$4,575	\$5,260	\$6,060	\$6,960
300-LBC	192-31 / \$4,107	117-505 / \$4,724	\$5,430	\$6,250	\$7,190
400-LBC	193-32 / \$4,836	117-506 / \$5,560	117-103 / \$6,410	\$7,350	\$8,460
500-LBC	194-32 / \$5,210	117-507 / \$5,990	\$6,900	\$7,930	\$9,130
600-LBC	174-36 / \$6,500	117-508 / \$7,490	\$8,610	\$9,900	\$11,400

35-LBC THROUGH 600-LBC

Additional Options:	Add to Base Model List Price
Sight Glass (SG):	\$320
Seismic Restraints (R):	\$225

Standard Leadtime:	125 & 150 PSI: 10 Days, 175 PSI: 30 Days, 250 & 300 PSI: 40 Days
Connection (NPTF):	Malleable Iron: All LBC Models: 1"
Factory Precharge:	All models: 12 PSI
Warranty:	1-Year Limited

APPLICATIONS & ORDERING

- For use in non-potable closed hydronic and chilled water systems.
- Constructed to ASME Section VIII, Division 1.

How to Order: Specify Model & Options

6-ASL-125

Step 1: Select Base Model Number
Step 2: Choose Pressure Rating

6-Inch Air Separator Less Strainer, 125 PSI Rating

TANGENTIAL AIR SEPARATORS, LESS STRAINER, ASME

J

TECHNICAL DATA

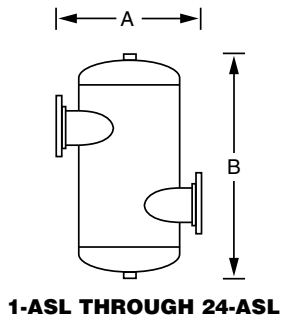

Base Model Number	Connection Size (In)	A Width (In)	B Height (In)	Shipping Weight (Lbs)				
				125 PSI	150 PSI	175 PSI	250 PSI	300 PSI
1-ASL	1	7	12	14	15	N/A	N/A	N/A
2-ASL	2	18	23	41	43	59	65	74
2 1/2-ASL	2-1/2	18	23	50	54	70	80	90
3-ASL	3	18	24	56	60	80	90	100
4-ASL	4	23	25	66	79	92	105	118
5-ASL	5	26	40	175	195	266	280	315
6-ASL	6	28	45	190	210	330	350	400
8-ASL	8	34	57	350	400	490	560	630
10-ASL	10	42	63	700	750	950	1,120	1,260
12-ASL	12	48	82	912	990	1,200	1,460	1,640
14-ASL	14	58	102	1,853	2,150	2,800	2,965	3,335
16-ASL	16	66	104	2,610	3,600	4,060	4,175	4,700
18-ASL	18	66	114	2,900	4,000	4,600	5,100	5,400
20-ASL	20	72	110	4,560	5,800	6,500	7,300	8,200
22-ASL	22	72	126	5,320	6,000	7,000	8,500	9,575
24-ASL	24	84	147	6,175	7,000	8,500	9,880	11,000

PRICING: ASME MODELS

Base Model Number	Part No. / List Price (USD)				
	125 PSI	150 PSI	175 PSI	250 PSI	300 PSI
1-ASL	489-1 / \$1,177	489-5 / \$1,298	N/A	N/A	N/A
2-ASL	490-22 / \$1,335	490-26 / \$1,467	\$1,867	490-28 / \$2,132	\$2,398
2 1/2-ASL	491-12 / \$1,511	491-15 / \$1,662	\$2,112	491-18 / \$2,418	491-16 / \$2,716
3-ASL	492-18 / \$1,825	492-27 / \$2,006	492-31 / \$2,556	492-32 / \$2,918	492-28 / \$3,289
4-ASL	493-23 / \$2,126	493-29 / \$2,338	493-33 / \$2,981	493-10 / \$3,405	493-31 / \$3,830
5-ASL	494-6 / \$2,518	494-23 / \$2,771	494-21 / \$3,523	494-17 / \$4,031	\$4,530
6-ASL	495-6 / \$3,083	495-28 / \$3,391	495-21 / \$4,286	495-17 / \$4,934	\$5,550
8-ASL	496-6 / \$4,174	496-26 / \$4,591	496-18 / \$5,850	496-14 / \$6,670	496-29 / \$7,510
10-ASL	497-6 / \$7,220	497-18 / \$7,940	497-27 / \$10,125	497-28 / \$11,550	497-21 / \$13,000
12-ASL	498-6 / \$8,330	498-19 / \$9,160	\$11,675	191-40 / \$13,325	191-38 / \$14,975
14-ASL	499-6 / \$14,200	499-46 / \$15,600	\$19,850	499-66 / \$22,700	\$25,550
16-ASL	499-24 / \$17,925	499-47 / \$19,725	\$25,075	\$28,675	502-4 / \$32,300
18-ASL	499-15 / \$27,075	499-48 / \$29,775	\$37,875	\$43,275	\$48,700
20-ASL	499-27 / \$35,575	499-49 / \$39,150	\$49,825	\$56,950	\$64,050
22-ASL	499-55 / \$41,275	499-31 / \$45,400	\$57,800	\$66,000	\$74,250
24-ASL	499-19 / \$47,400	499-50 / \$52,100	\$66,400	\$75,850	\$85,300

Additional Options: Grooved Pipe Connectors (G): Available on models 2-ASL through 14-ASL at no additional charge.
Standard Leadtime: 1-ASL through 12-ASL: 10 Days, 14-ASL through 18-ASL: 30 Days, 20-ASL through 24-ASL: Consult Amtrol Customer Service. Add 10 days to Standard Leadtime for Grooved Pipe Connectors (G).
Connection: 125, 150, and 175 PSI: 150# flanges; 250 and 300 PSI: 300# flanges.
Warranty: 1-Year Limited

APPLICATIONS & ORDERING

- For use in non-potable closed hydronic and chilled water systems.
- Choose from Tangential (vortex) or Inline (air scoop) styles.
- Constructed to ASME Section VIII, Division 1.

How to Order: Specify Model & Options

6-AS-125

Step 1: Select Base Model Number
Step 2: Choose Pressure Rating

6-Inch Air Separator With Strainer, 125 PSI Rating

TANGENTIAL AIR SEPARATORS, WITH STRAINER, ASME

J

TECHNICAL DATA

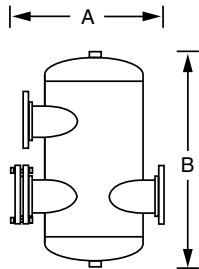

2-AS THROUGH 24-AS

Base Model Number	Connection Size (In)	A Width (In)	B Height (In)	Shipping Weight (Lbs)				
				125 PSI	150 PSI	175 PSI	250 PSI	300 PSI
2-AS	2	18	23	45	47	63	72	81
2 1/2-AS	2-1/2	18	23	54	58	75	86	97
3-AS	3	18	24	60	64	84	96	108
4-AS	4	23	25	70	83	98	112	126
5-AS	5	26	40	200	220	280	320	360
6-AS	6	28	45	249	261	348	398	448
8-AS	8	34	57	375	445	525	600	675
10-AS	10	42	63	750	800	1,050	1,200	1,350
12-AS	12	48	82	950	1,060	1,330	1,520	1,710
14-AS	14	58	102	2,200	2,500	3,080	3,520	3,960
16-AS	16	66	104	3,000	3,900	4,200	4,800	5,400
18-AS	18	66	114	3,500	4,700	4,900	5,600	6,300
20-AS	20	72	110	5,000	6,100	7,000	8,000	9,000
22-AS	22	72	126	5,500	6,600	7,700	8,800	9,900
24-AS	24	84	147	7,000	8,400	9,800	11,200	12,600

PRICING: ASME MODELS

Base Model Number	Part No. / List Price (USD)				
	125 PSI	150 PSI	175 PSI	250 PSI	300 PSI
2-AS	490-23 / \$1,495	490-25 / \$1,719	490-27 / \$2,090	\$2,388	\$2,694
2 1/2-AS	491-13 / \$1,653	491-14 / \$1,901	491-17 / \$2,312	\$2,642	\$2,971
3-AS	492-19 / \$2,216	492-26 / \$2,547	492-30 / \$3,098	492-29 / \$3,543	492-33 / \$3,989
4-AS	493-24 / \$2,398	493-28 / \$2,758	493-32 / \$3,353	493-30 / \$3,841	\$4,318
5-AS	494-7 / \$3,217	494-22 / \$3,701	\$4,498	\$5,150	494-16 / \$5,790
6-AS	495-7 / \$3,990	495-27 / \$4,589	495-20 / \$5,590	495-31 / \$6,390	\$7,180
8-AS	496-7 / \$5,150	496-25 / \$5,920	496-20 / \$7,210	496-10 / \$8,240	496-36 / \$9,270
10-AS	497-7 / \$8,780	497-17 / \$10,100	497-22 / \$12,275	497-20 / \$14,025	497-23 / \$15,800
12-AS	498-7 / \$10,625	498-18 / \$13,100	498-21 / \$14,900	191-44 / \$17,025	498-23 / \$19,150
14-AS	499-7 / \$17,725	499-41 / \$20,375	499-69 / \$24,800	499-71 / \$28,350	499-74 / \$31,875
16-AS	499-10 / \$21,950	499-42 / \$25,225	499-68 / \$30,725	502-2 / \$35,100	502-1 / \$39,500
18-AS	499-33 / \$33,775	499-43 / \$38,850	503-03 / \$47,325	503-1 / \$54,100	499-73 / \$60,800
20-AS	499-29 / \$44,475	499-44 / \$51,150	\$62,250	499-70 / \$71,150	499-72 / \$80,050
22-AS	499-35 / \$63,900	499-54 / \$73,550	\$89,500	\$102,300	\$115,200
24-AS	499-40 / \$72,700	499-45 / \$83,600	\$101,800	\$116,400	\$130,900

Additional Options: Grooved Pipe Connectors (G): Available on models 2-AS through 14-AS at no additional charge.
Standard Leadtime: 2-AS through 12-AS: 10 Days, 14-AS through 18-AS: 30 Days, 20-AS through 24-AS: Consult Amtrol Customer Service. Add 10 days to Standard Leadtime for Grooved Pipe Connectors (G).
Connection: 125, 150, and 175 PSI: 150# flanges; 250 and 300 PSI: 300# flanges.
Warranty: 1-Year Limited

APPLICATIONS & ORDERING

- For use in closed, non-potable water systems.
- Eliminates entrained air and separates debris associated with start-up and maintenance of any hydronic system.
- Constructed to ASME Section VIII, Division 1.

How to Order: Specify Model & Options

3-ADS-125

Step 1: Select Base Model Number
Step 2: Choose Pressure Rating

3-inch Air & Dirt Separator, 125 PSI Rating

AIR & DIRT SEPARATORS, ASME

TECHNICAL DATA

Base Model Number	Connection Size (In)	A Width (In)	B Height (In)	Shipping Weight (Lbs)	
				125 PSI	150 PSI
2-ADS	2	15	23	60	65
3-ADS	3	20	29	92	97
4-ADS	4	21	29	102	110
5-ADS	5	28	42	144	154
6-ADS	6	28	42	149	159
8-ADS	8	34	49	258	270
10-ADS	10	38	64	384	395
12-ADS	12	43	75	533	550

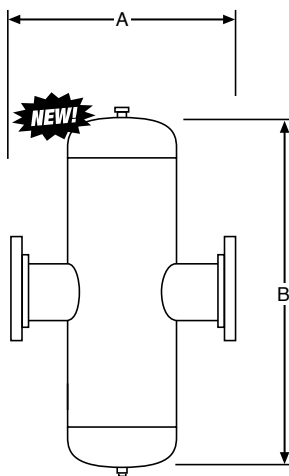

2-ADS THROUGH 12-ADS

PRICING: ASME MODELS

Base Model Number	Part No. / List Price (USD)	
	125 PSI	150 PSI
2-ADS	523-01 / \$3,265	523-02 / \$3,605
3-ADS	523-03 / \$4,295	523-07 / \$4,738
4-ADS	523-04 / \$5,410	523-09 / \$5,970
5-ADS	523-05 / \$8,090	523-11 / \$8,910
6-ADS	523-06 / \$11,325	523-12 / \$12,475
8-ADS	523-08 / \$18,225	523-13 / \$20,050
10-ADS	523-10 / \$28,025	523-14 / \$30,825
12-ADS	523-20 / \$37,900	523-21 / \$41,725

Additional Options:
Standard Leadtime:
Connection:
Warranty:

Grooved Pipe Connectors (G): Available on models 2-ADS through 12-ADS at no additional charge.
2-ADS through 12-ADS: 30 Days. Add 10 days to Standard Leadtime for Grooved Pipe Connectors (G).
125 and 150 PSI: 150# flanges.
1-Year Limited.

INLINE AIR PURGERS

- Eliminate air in closed hydronic or chilled water systems.

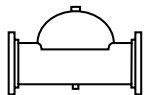

Model Number	Connection Size (In)	Shipping Weight (Lbs)		Part No. / List Price (USD)	
		125 PSI	150 PSI	125 PSI	150 PSI
449*	4	56	NA	449-1 / \$535	NA
461*	5	NA	60	NA	461-1 / \$1,981
462*	6	NA	65	NA	462-1 / \$2,137
463*	8	NA	113	NA	463-1 / \$2,861
464*	10	NA	174	NA	464-1 / \$4,533
465*	12	NA	330	NA	465-1 / \$5,420
466*	14	NA	500	NA	466-1 / \$8,640
467	16	NA	231	NA	467-1 / \$9,860 *150 PSI ANSI Flanges
468	18	NA	573	NA	468-1 / \$11,350

Standard Leadtime:
Warranty:

Model 449 through 465: 10 Days, Model 466 through 468: 20 Days.
1-Year Limited

Air Vents & Plain Steel Tanks

HIGH CAPACITY AIR VENT

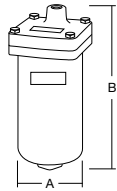

Model Number	Description	A Diameter (In)	B Height (In)	Shipping Weight (Lbs)	List Price (USD)
747	117-472 High Capacity Vent	4	10	8	\$974
Repair Kit	117-524 Repair Kit & Gasket Assy			1	\$161

For venting air from closed hydronic or chilled water systems.

Standard Leadtime: Vent and Repair Kit: 10 Days **Warranty:** 1-Year Limited

AC MODELS: PLAIN STEEL COMPRESSION TANKS, ASME



AC12-15 THROUGH AC36-505

PRICING: ASME MODELS

Model Number	Volume (Gal)	A-Diameter (In)	B-Length (In)	Shipping Weight (Lbs)		Part No. / List Price (USD)	
				125 PSIG	150 PSIG	125 PSIG	150 PSIG
AC12-15	15	12	33	NA	44	NA	183-8014 / \$911
AC12-24	24	12	51	NA	62	NA	183-8015 / \$959
AC14-30	30	14	48	NA	72	NA	183-8016 / \$1,168
AC14-40	40	14	63	NA	92	NA	183-8017 / \$1,357
AC16-60	60	16	72	NA	120	NA	183-8018 / \$1,580
AC20-80	80	20	63	136	NA	183-8019 / \$1,585	NA
AC20-100	100	20	78	168	NA	183-8020 / \$2,367	NA
AC24-120	120	24	65	218	NA	183-8021 / \$2,956	NA
AC24-135	135	24	72	238	NA	183-8022 / \$3,048	NA
AC30-175	175	30	62	338	NA	183-8023 / \$4,550	NA
AC30-220	220	30	77	368	NA	183-8024 / \$5,340	NA
AC30-240	240	30	84	394	NA	183-8025 / \$5,440	NA
AC30-305	305	30	106	486	NA	183-8026 / \$5,700	NA
AC36-400	400	36	93	645	NA	183-8028 / \$5,930	NA
AC36-505	505	36	120	810	NA	183-8029 / \$6,500	NA

Maximum Operating Temperature: 450° F

For use in closed hydronic and chilled water systems.

Standard Leadtime: AC12-15 through AC30-305: 20 days. AC36-400 through AC36-505: 30 days.

Working Pressure: AC12-15 through AC16-60:150 PSI. AC20-80 through AC36-505: 125 PSI.

Warranty: 1-Year Limited

APPLICATIONS & ORDERING

- For use in non-potable closed chilled water systems.
- Available with 3" to 12" connections.
- Constructed to ASME Section VIII, Division 1.

How to Order: Specify Model & Options

CWBT500-6-125 R



- Step 1: Select Base Model Number
 Step 2: Specify Sensor Ports
 Step 3: Specify Restraint Option (or leave blank)

CWBT500-6 125 PSI Rating with Restraints

CWBT MODELS: CHILLED WATER BUFFER TANKS, ASME

TECHNICAL DATA

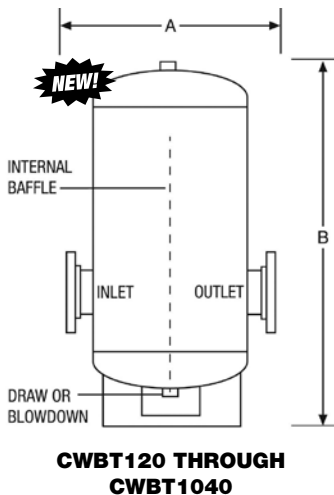

Base Model Number	Volume (Gal)	A Width (In)	B Height (In)	Connection Size (In)	Shipping Weight (Lbs)	
					125 PSI	150 PSI
CWBT120-3	120	33	56	3	294	323
CWBT120-4	120	33	56	4	315	347
CWBT120-6	120	33	56	6	333	366
CWBT200-3	200	39	63	3	527	580
CWBT200-4	200	39	63	4	547	602
CWBT200-6	200	39	63	6	566	623
CWBT300-3	300	45	80	3	740	800
CWBT300-4	300	45	80	4	753	828
CWBT300-6	300	45	80	6	772	849
CWBT300-8	300	45	80	8	801	881
CWBT500-6	500	51	99	6	1,366	1,503
CWBT500-8	500	51	99	8	1,395	1,535
CWBT500-10	500	51	99	10	1,490	1,639
CWBT850-6	850	64	115	6	2,707	2,978
CWBT850-8	850	64	115	8	2,736	3,010
CWBT850-10	850	64	115	10	2,771	3,048
CWBT1040-8	1040	70	108	8	3,136	3,450
CWBT1040-10	1040	70	108	10	3,171	3,488
CWBT1040-12	1040	70	108	12	3,283	3,611

PRICING: ASME MODELS

Base Model Number	Part No. / List Price (USD)	
	125 PSI	150 PSI
CWBT120-3	517-01 / \$4,530	517-28 / \$5,430
CWBT120-4	517-02 / \$4,764	517-19 / \$5,720
CWBT120-6	517-03 / \$5,190	\$6,230
CWBT200-3	517-04 / \$5,930	\$7,120
CWBT200-4	517-05 / \$6,250	517-31 / \$7,500
CWBT200-6	517-06 / \$6,840	517-21 / \$8,210
CWBT300-3	517-20 / \$7,420	\$8,900
CWBT300-4	517-07 / \$7,470	\$8,960
CWBT300-6	517-08 / \$7,840	\$9,410
CWBT300-8	517-09 / \$8,590	517-27 / \$10,300
CWBT500-6	517-10 / \$14,425	517-34 / \$17,325
CWBT500-8	517-11 / \$15,150	\$18,175
CWBT500-10	517-12 / \$16,600	\$19,925
CWBT850-6	517-13 / \$21,500	517-25 / \$25,800
CWBT850-8	517-14 / \$22,625	\$27,175
CWBT850-10	517-15 / \$24,750	\$29,725
CWBT1040-8	517-16 / \$28,575	\$34,325
CWBT1040-10	517-17 / \$29,975	\$35,975
CWBT1040-12	517-18 / \$32,850	\$39,450

Additional Options: Add to Base Model List Price
Seismic Restraints (R): \$225
Sensor Ports (SP): \$320
Grooved Pipe Connectors (G): No Additional Charge - Add 2 Weeks to Leadtime

Standard Leadtime: CWBT120-3 through CWBT300-8: 10 Days; CWBT500-6 through CWBT850-10: 30 Days; CWBT1040-8 through CWBT1040-12: Consult Amtrol Customer Service.

Connection: 125 and 150 PSI: 150# flanges.
Warranty: 1-Year Limited

APPLICATIONS & ORDERING

- For use in non-potable closed heating systems.
- Available with 2" to 4" connections.
- Constructed to ASME Section VIII, Division 1.
- Maximum Operating Temperature: 450° F.

How to Order: Specify Model & Options

HWBT120-2-125SPR

- Step 1: Select Base Model Number
 Step 2: Specify Sensor Ports
 Step 3: Specify Restraint Option (or leave blank)



HWBT120-2 125 PSI Rating with Sensor Ports and Restraints

HWBT MODELS: HOT WATER BUFFER TANKS, ASME

J

TECHNICAL DATA

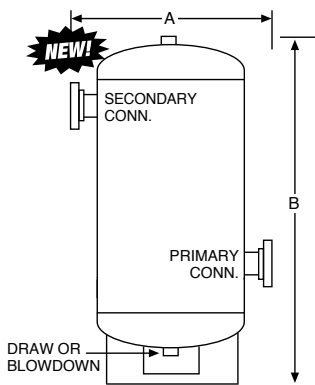

HWBT120-2 THROUGH HWBT300-3

Base Model Number	Volume (Gal)	A Width (In)	B Height (In)	Primary Connection Size (In)	Secondary Connection Size (In)	Shipping Weight (Lbs)	
						125 PSI	150 PSI
HWBT120-2	120	33	56	2	2	254	279
HWBT120-3	120	33	56	3	3	268	295
HWBT200-2	200	39	63	2	2	475	523
HWBT200-3	200	39	63	3	3	490	539
HWBT300-2	300	45	80	2	2	668	735
HWBT300-2.5	300	45	80	2.5	2.5	677	745
HWBT300-3	300	45	80	3	3	683	751
HWBT120-2/2	120	33	56	2	2	267	294
HWBT120-2/3	120	33	56	2	3	282	310
HWBT120-3/3	120	33	56	3	3	297	327
HWBT120-4/4	120	33	56	4	4	338	372
HWBT120-6/6	120	33	56	6	6	356	392
HWBT200-2/2	200	39	63	2	2	489	538
HWBT200-2/3	200	39	63	2	3	503	553
HWBT200-3/3	200	39	63	3	3	518	570
HWBT200-4/4	200	39	63	4	4	560	617
HWBT300-2/2	300	45	80	2	2	682	750
HWBT300-2/3	300	45	80	2	3	696	766
HWBT300-3/3	300	45	80	3	3	711	782
HWBT300-4/4	300	45	80	4	4	753	828

PRICING: ASME MODELS

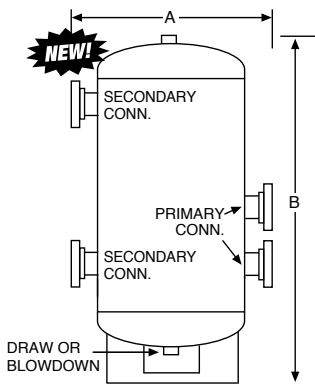

HWBT120-2/2 THROUGH HWBT300-4/4

Base Model Number	Part No. / List Price (USD)	
	125 PSI	150 PSI
HWBT120-2	527-101 / \$3,819	\$4,584
HWBT120-3	527-102 / \$4,063	\$4,880
HWBT200-2	527-201 / \$5,120	\$6,150
HWBT200-3	527-202 / \$5,300	527-209 / \$6,370
HWBT300-2	527-301 / \$6,820	\$8,190
HWBT300-2.5	\$6,940	527-309 / \$8,340
HWBT300-3	527-302 / \$7,070	\$8,490
HWBT120-2/2	527-103 / \$5,060	\$6,070
HWBT120-2/3	527-104 / \$5,270	\$6,320
HWBT120-3/3	527-105 / \$5,490	\$6,580
HWBT120-4/4	527-106 / \$5,700	\$6,830
HWBT120-6/6	527-107 / \$6,550	\$7,860
HWBT200-2/2	527-203 / \$6,300	\$7,560
HWBT200-2/3	527-204 / \$6,510	\$7,820
HWBT200-3/3	527-205 / \$6,730	527-208 / \$8,080
HWBT200-4/4	527-206 / \$6,940	\$8,330
HWBT300-2/2	527-303 / \$8,060	\$9,670
HWBT300-2/3	527-304 / \$8,270	\$9,930
HWBT300-3/3	527-305 / \$8,490	527-310 / \$10,175
HWBT300-4/4	527-306 / \$8,780	\$10,525

- Additional Options:** Add to Base Model List Price
Seismic Restraints (R): \$225
Sensor Ports (SP): \$320
Grooved Pipe Connectors (G): No Additional Charge - Add 2 Weeks to Leadtime

- Standard Leadtime:** All Models 10 days.
 Add 10 days to Standard Leadtime for Grooved Pipe Connectors (G).
Connection: 125 and 150 PSI: 150# flanges.
Warranty: 1-Year Limited

APPLICATIONS & ORDERING

- For use in potable hot water systems.
- Fixed diaphragm construction.
- Constructed to ASME Section VIII, Division 1.
- Maximum Operating Temperature: 200° F.

How to Order: Specify Model & Options

ST-80VC-150SGR

- Step 1: Select Base Model Number
 Step 2: Choose Pressure Rating
 Step 3: Specify Sight Glass Option (or leave blank)
 Step 4: Specify Restraint Option (or leave blank)

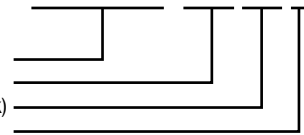

ST-80VC 150 PSI Rating with Sight Glass & Restraints

ST MODELS: DIAPHRAGM TYPE, ASME

J

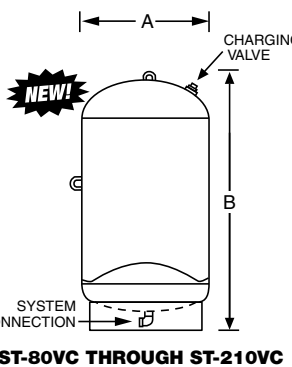
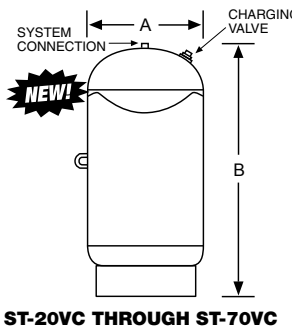
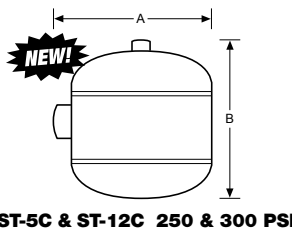
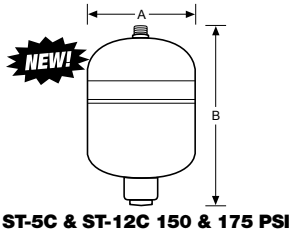

TECHNICAL DATA

Base Model Number	Volume (Gal)	Max Acceptance Volume (Gal)	A Diameter (In)	B Height (In)	Shipping Weight (Lbs)			
					150 PSI	175 PSI	250 PSI	300 PSI
ST-5C	2.0	0.9	8	14	10	12	NA	NA
ST-5C	2.1	0.9	10	10	NA	NA	25	30
ST-12C	6.4	3.2	12	18	17	19	NA	NA
ST-12C	6.4	3.2	12	14	NA	NA	42	50
ST-20VC	8.0	3.2	12	19	41	43	50	62
ST-30VC	14.0	9.0	16	19	59	64	96	108
ST-42VC	18.0	11.0	16	24	71	75	101	112
ST-60VC	25.0	11.0	16	32	85	113	125	139
ST-70VC	34.0	11.0	16	45	99	122	136	151
ST-80VC	53.0	35.0	24	37	224	296	305	340
ST-120VC	68.0	35.0	24	44	266	340	375	400
ST-180VC	77.0	35.0	24	49	285	360	380	420
ST-210VC	90.0	35.0	24	57	319	380	405	440

PRICING: ASME MODELS

Base Model Number	Part No. / List Price (USD)			
	150 PSI	175 PSI	250 PSI	300 PSI
ST-5C	140-004 / \$1,752	140-002 / \$1,926	140-751 / \$2,119	140-732 / \$2,331
ST-12C	141-008 / \$2,289	141-007 / \$2,516	141-354 / \$2,769	141-355 / \$3,046
ST-20VC	142-149 / \$2,378	142-185 / \$2,617	142-181 / \$2,879	142-186 / \$3,167
ST-30VC	143-327 / \$2,685	146-830 / \$2,954	143-349 / \$3,249	143-368 / \$3,573
ST-42VC	144-207 / \$2,869	146-831 / \$3,156	144-245 / \$3,471	\$3,818
ST-60VC	146-776 / \$3,330	146-804 / \$3,665	146-828 / \$4,030	146-811 / \$4,433
ST-70VC	146-790 / \$3,440	146-827 / \$3,785	146-829 / \$4,163	146-835 / \$4,580
ST-80VC	147-139 / \$4,919	147-239 / \$5,410	147-216 / \$5,950	147-231 / \$6,560
ST-120VC	147-199 / \$5,160	147-240 / \$5,690	147-241 / \$6,250	147-232 / \$6,870
ST-180VC	148-109 / \$5,380	148-168 / \$5,920	148-170 / \$6,510	\$7,170
ST-210VC	148-110 / \$5,650	148-169 / \$6,220	148-171 / \$6,840	\$7,520

Additional Options: Add to Base Model List Price
Sight Glass (SG): \$320
Seismic Restraints (R): \$225

Standard Leadtime: 150 PSI: 10 Days, 175 PSI: 20 Days, 250 PSI: 30 Days, 300 PSI: 40 Days
Connection: Stainless Steel: ST-5C 150 PSI and 175 PSI: 3/4" NPTM, ST-5C 250 PSI and 300 PSI: 3/4" NPTF, ST-12C through ST-70VC: 3/4" NPTF, ST-80VC through ST-210VC: 1 1/4" NPTF

Factory Precharge: All models: 55 PSI
Warranty: 1-Year Limited



APPLICATIONS & ORDERING

- For use in potable hot water systems.
- Replaceable bladder construction.
- Available in ASME Code (C) and non-ASME construction.
- Maximum Operating Temperature: 240° F.

How to Order: Specify Model & Options

ST-448C-125SGR

- Step 1: Select Base Model Number
 Step 2: Choose Pressure Rating
 Step 3: Specify Sight Glass Option (or leave blank)
 Step 4: Specify Restraint Option (or leave blank)

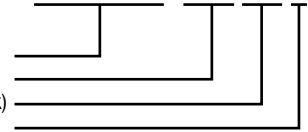

ST-448C 125 PSI Rating with Sight Glass & Restraints

ST-C (ASME) and ST (NON-ASME) MODELS: FULL ACCEPTANCE BLADDER

J

TECHNICAL DATA

Base Model Number	Volume (Gal)	Max Acceptance Volume (Gal)	A Diameter (In)	B Height (In)	Shipping Weight (Lbs)				
					125 PSI	150 PSI	175 PSI	250 PSI	300 PSI
ST-447C	53	53	24	45	236	262	290	370	425
ST-448C	80	80	24	59	274	340	430	492	540
ST-449C	106	106	24	73	320	360	450	510	560
ST-450C	132	132	24	87	354	400	460	570	632
ST-451(C)	158	158	30	73	494	587	680	815	895
ST-452(C)	211	211	30	91	593	625	699	1,005	1,107
ST-453(C)	264	264	36	86	667	760	845	1,100	1,205
ST-454(C)	317	317	36	98	762	850	960	1,265	1,400
ST-455(C)	370	370	36	110	842	935	1,065	1,350	1,490
ST-456(C)	422	422	48	82	1,152	1,423	1,650	1,660	1,830
ST-457(C)	528	528	48	97	1,335	1,505	1,875	2,230	2,455

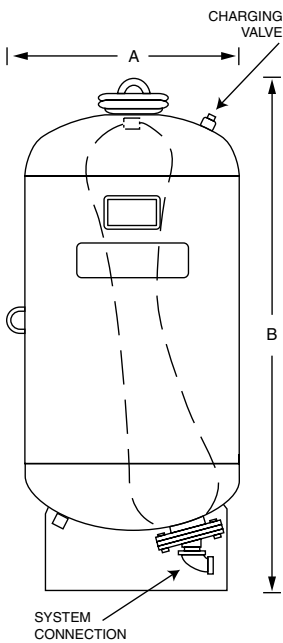

ST-447C THROUGH ST-457C

PRICING: ASME MODELS

Base Model Number	Part No. / List Price (USD)				
	125 PSI	150 PSI	175 PSI	250 PSI	300 PSI
ST-447C	183-48 / \$6,640	183-66 / \$7,310	\$8,400	183-70 / \$9,660	\$11,125
ST-448C	183-49 / \$7,710	183-67 / \$8,490	183-88 / \$9,330	\$10,275	\$11,300
ST-449C	183-50 / \$8,990	183-68 / \$9,900	183-93 / \$10,875	183-56 / \$12,000	183-127 / \$13,150
ST-450C	183-51 / \$10,250	183-69 / \$11,275	\$12,400	183-134 / \$13,625	183-135 / \$14,975
ST-451C	184-38 / \$11,400	184-69 / \$12,550	184-73 / \$13,800	184-40 / \$15,175	184-79 / \$16,675
ST-452C	185-38 / \$12,525	185-60 / \$13,775	185-39 / \$15,175	185-40 / \$16,650	\$18,325
ST-453C	186-38 / \$14,750	186-60 / \$16,225	186-39 / \$17,850	\$19,625	\$21,575
ST-454C	181-38 / \$15,200	181-53 / \$16,700	181-39 / \$18,375	\$20,225	\$22,225
ST-455C	182-38 / \$16,475	182-56 / \$18,100	\$19,925	\$21,925	\$24,100
ST-456C	187-38 / \$21,625	187-58 / \$23,825	\$26,225	187-40 / \$28,850	\$31,700
ST-457C	188-38 / \$23,125	118-68 / \$25,450	\$29,100	188-99 / \$30,800	\$33,850

PRICING: NON-ASME MODELS

Base Model Number	Part No. / List Price (USD) 150 PSI
ST-451	184-43 / \$10,025
ST-452	185-43 / \$10,225
ST-453	186-43 / \$11,850
ST-454	181-43 / \$12,625
ST-455	182-43 / \$13,375
ST-456	187-43 / \$17,475
ST-457	188-43 / \$18,650

Additional Options: Add to Base Model List Price
Sight Glass (SG): \$320
Seismic Restraints (R): \$225

Standard Leadtime: 125 & 150 PSI: 10 Days, 175 PSI: 30 Days, 250 & 300 PSI: 40 Days
Connection (NPTF): Bronze: ST-447 through ST-452: 2", ST-453 through ST-457: 3"
Factory Precharge: All models: 55 PSI
Warranty: 1-Year Limited



APPLICATIONS & ORDERING

- For use in potable hot water systems
- Replaceable diaphragm construction.
- Available in ASME Code (C) and non-ASME construction.
- Maximum Operating Temperature: 240° F.

How to Order: Specify Model & Options

ST-100CL-150SGR

- Step 1: Select Base Model Number
 Step 2: Choose Pressure Rating
 Step 3: Specify Sight Glass Option (or leave blank)
 Step 4: Specify Restraint Option (or leave blank)

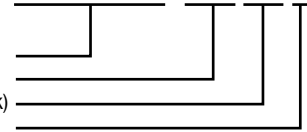

ST-100CL 150 PSI Rating with Sight Glass & Restraints

ST-CL (ASME) and ST-L (NON-ASME) MODELS: PARTIAL ACCEPTANCE BLADDER

J

TECHNICAL DATA

Base Model Number	Volume (Gal)	Max Acceptance Volume (Gal)	A Diameter (In)	B Height (In)	Shipping Weight (Lbs)
ST-35L(CL)	10	10	10	37	76
ST-50L(CL)	13	11	12	37	78
ST-85L(CL)	22	11	16	35	95
ST-100L(CL)	26	11	16	39	102
ST-130L(CL)	34	27	20	35	134
ST-165L(CL)	44	27	20	40	153
ST-200L(CL)	53	27	24	41	205
ST-300L(CL)	80	27	24	56	254
ST-400L(CL)	106	53	24	69	308
ST-500L(CL)	132	53	24	83	352
ST-600L(CL)	158	53	30	67	442

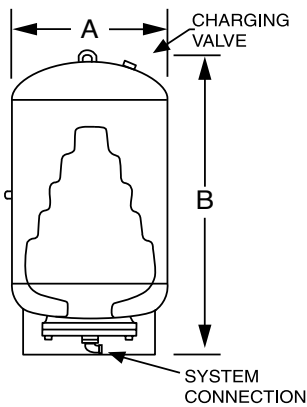

ST-35CL THROUGH ST-600CL

PRICING: ASME MODELS

Base Model Number	Part No. / List Price (USD)
150 PSI	
ST-35CL	165-6 / \$4,530
ST-50CL	166-6 / \$4,591
ST-85CL	167-5 / \$4,709
ST-100CL	168-5 / \$4,762
ST-130CL	169-5 / \$4,998
ST-165CL	171-16 / \$5,180
ST-200CL	191-34 / \$5,350
ST-300CL	192-32 / \$5,540
ST-400CL	193-33 / \$6,420
ST-500CL	194-33 / \$6,670
ST-600CL	174-38 / \$8,180

PRICING: NON-ASME MODELS

Base Model Number	Part No. / List Price (USD)
150 PSI	
ST-35L	165-7 / \$4,453
ST-50L	166-7 / \$4,513
ST-85L	167-6 / \$4,629
ST-100L	168-6 / \$4,679
ST-130L	169-6 / \$4,913
ST-165L	171-17 / \$5,090
ST-200L	191-35 / \$5,250
ST-300L	192-33 / \$5,440
ST-400L	193-34 / \$6,300
ST-500L	194-34 / \$6,560
ST-600L	174-39 / \$8,050

Additional Options: Add to Base Model List Price
Sight Glass (SG): \$320
Seismic Restraints (R): \$225

Standard Leadtime: All models 10 Days
Connection (NPTF): Stainless Steel: All Models: 1"
Factory Precharge: All models: 55 PSI
Warranty: 1-Year Limited



APPLICATIONS & ORDERING

- For use in water well and booster pump applications.
- Fixed diaphragm construction.
- Available in ASME Code (C) and non-ASME construction.
- Maximum Operating Temperature: 200° F.

How to Order: Specify Model & Options

WX-403C-125SGR

- Step 1: Select Base Model Number
 Step 2: Choose Pressure Rating
 Step 3: Specify Sight Glass Option (or leave blank)
 Step 4: Specify Restraint Option (or leave blank)

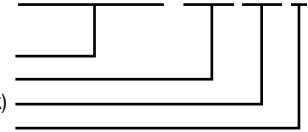

WX-403C (ASME) 125 PSI Rating with Sight Glass & Restraints

WX-C (ASME) and WX (NON-ASME) MODELS: DIAPHRAGM TYPE

J

TECHNICAL DATA

Base Model Number	Volume (Gal)	Max Acceptance Volume (Gal)	A Diameter (In)	B Height (In)	Shipping Weight (Lbs)				
					125 PSI	150 PSI	175 PSI	250 PSI	300 PSI
WX-401(C)	18	11	16	31	77	96	110	126	133
WX-402(C)	25	11	16	40	93	113	125	145	160
WX-403(C)	34	11	16	49	115	120	145	183	200
WX-404(C)	68	34	24	48	227	232	313	411	432
WX-405(C)	90	34	24	59	252	255	384	433	460
WX-406(C)	110	34	24	70	286	335	402	475	500
WX-407(C)	132	46	30	57	436	450	510	570	625

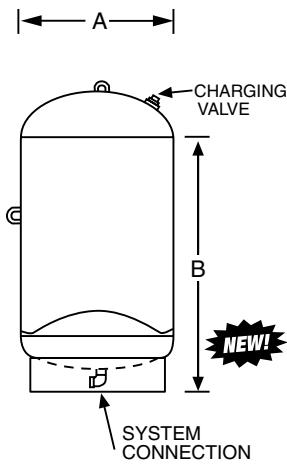

WX-401(C) THROUGH WX-407(C)

PRICING: ASME MODELS

Base Model Number	Part No. / List Price (USD)				
	125 PSI	150 PSI	175 PSI	250 PSI	300 PSI
WX-401C	144-80 / \$2,594	144-258 / \$2,854	144-160 / \$3,140	144-82 / \$3,455	\$3,799
WX-402C	145-80 / \$2,976	145-1000 / \$3,273	145-70 / \$3,601	145-95 / \$3,961	145-1003 / \$4,357
WX-403C	146-80 / \$3,242	146-807 / \$3,567	146-760 / \$3,924	146-768 / \$4,317	172-01 / \$4,748
WX-404C	147-80 / \$4,809	147-228 / \$5,290	147-129 / \$5,820	147-125 / \$6,410	173-01 / \$7,050
WX-405C	149-80 / \$5,030	149-155 / \$5,540	149-41 / \$6,090	149-40 / \$6,700	173-03 / \$7,370
WX-406C	149-138 / \$5,280	149-156 / \$5,810	149-144 / \$6,400	149-160 / \$7,030	149-169 / \$7,740
WX-407C	149-139 / \$5,960	149-157 / \$6,570	149-159 / \$7,220	149-146 / \$7,940	149-170 / \$8,740

PRICING: NON-ASME MODELS

Base Model Number	Part No. / List Price (USD)	
	150 PSI	
WX-401	144-74 / \$2,619	
WX-402	145-74 / \$2,814	
WX-403	146-74 / \$2,938	
WX-404	147-74 / \$3,704	
WX-405	149-74 / \$3,873	
WX-406	149-142 / \$4,361	
WX-407	149-143 / \$4,818	

Additional Options:	Add to Base Model List Price
Sight Glass (SG):	\$320
Seismic Restraints (R):	\$225

Standard Leadtime:	125 & 150 PSI: 10 days, 175 PSI: 20 days, 250 & 300 PSI: 30 days,
Connection (NPTF):	Malleable Iron: WX-401 through WX-403: 1", WX-404 through WX-407: 1-1/4"
Factory Precharge:	All models: 30 PSI
Warranty:	1-Year Limited

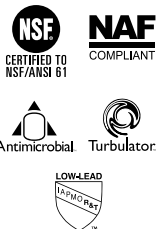

APPLICATIONS & ORDERING

- For use in water well and booster pump applications.
- Replaceable bladder design.
- Available in ASME Code (C) and non-ASME construction.
- Maximum Operating Temperature: 240° F.

How to Order: Specify Model & Options

WX-448C-175SGR

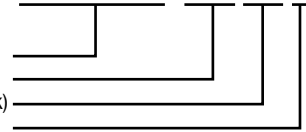

- Step 1: Select Base Model Number
 Step 2: Choose Pressure Rating
 Step 3: Specify Sight Glass Option (or leave blank)
 Step 4: Restraint Option (or leave blank)

WX-448C (ASME) 175 PSI Rating with Sight Glass & Restraints

WX-C (ASME) and WX (NON-ASME) MODELS: FULL ACCEPTANCE BLADDER

J

TECHNICAL DATA

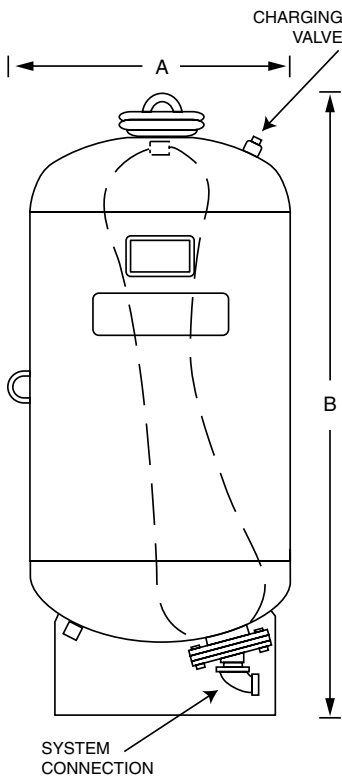

Base Model Number	Volume (Gal)	Max Acceptance Volume (Gal)	A Diameter (In)	B Height (In)	Shipping Weight (Lbs)					
					100 PSI	125 PSI	150 PSI	175 PSI	250 PSI	300 PSI
WX-421	158	158	30	75	388	N/A	N/A	N/A	N/A	N/A
WX-422	211	211	30	93	454	N/A	N/A	N/A	N/A	N/A
WX-423	264	264	36	82	506	N/A	N/A	N/A	N/A	N/A
WX-424	317	317	36	95	571	N/A	N/A	N/A	N/A	N/A
WX-426	422	422	48	82	971	N/A	N/A	N/A	N/A	N/A
WX-427	528	528	48	96	1,222	N/A	N/A	N/A	N/A	N/A
WX-447(C)	53	53	24	45	N/A	263	289	368	420	462
WX-448(C)	80	80	24	59	N/A	315	338	430	492	540
WX-449(C)	106	106	24	73	N/A	319	350	440	507	557
WX-450(C)	132	132	24	87	N/A	351	392	454	570	627
WX-451(C)	158	158	30	73	N/A	493	587	680	813	894
WX-452(C)	211	211	30	91	N/A	602	627	694	1,007	1,107
WX-453(C)	264	264	36	86	N/A	676	752	846	1,095	1,204
WX-454(C)	317	317	36	98	N/A	762	840	959	1,264	1,390
WX-455(C)	370	370	36	110	N/A	843	930	1,060	1,350	1,485
WX-456(C)	422	422	48	82	N/A	1,154	1,418	1,655	1,700	1,826
WX-457(C)	528	528	48	97	N/A	1,331	1,500	1,870	2,231	2,450
WX-458C	660	660	60	84	N/A	1,450	1,740	2,030	2,320	2,750
WX-459C	792	792	60	99	N/A	2,169	2,385	3,036	3,470	3,690
WX-460C	925	925	60	107	N/A	2,300	2,530	3,220	3,680	3,910
WX-461C	1,056	1,056	60	121	N/A	2,638	2,900	3,695	4,220	4,485
WX-462C	1,320	1,320	72	108	N/A	3,500	3,850	4,900	5,600	5,950
WX-463C	1,980	1,980	72	140	N/A	4,100	4,510	5,740	6,560	6,970

WX-447 through WX-457 Non-ASME available in 150 PSI only.

PRICING: ASME MODELS

Base Model Number	Part No. / List Price (USD)				
	125 PSI	150 PSI	175 PSI	250 PSI	300 PSI
WX-447C	183-18 / \$7,320	183-62 / \$8,050	183-38 / \$8,860	183-25 / \$9,750	183-122 / \$10,700
WX-448C	183-19 / \$7,360	183-63 / \$8,100	183-46 / \$8,900	183-26 / \$9,810	183-116 / \$10,775
WX-449C	183-17 / \$7,670	183-64 / \$8,440	183-23 / \$9,270	183-27 / \$10,200	183-99 / \$11,225
WX-450C	183-20 / \$7,970	183-65 / \$8,770	183-100 / \$9,630	183-28 / \$10,600	183-52 / \$11,675
WX-451C	184-35 / \$9,940	184-70 / \$10,950	184-41 / \$12,050	184-42 / \$13,250	184-74 / \$14,550
WX-452C	185-35 / \$10,975	185-61 / \$12,075	185-41 / \$13,275	185-42 / \$14,625	185-56 / \$16,075
WX-453C	186-35 / \$13,400	186-62 / \$14,725	186-41 / \$16,175	186-42 / \$17,825	186-68 / \$19,600
WX-454C	181-35 / \$14,250	181-55 / \$15,650	181-41 / \$17,200	181-42 / \$18,925	\$20,850
WX-455C	182-35 / \$15,125	182-58 / \$16,600	182-41 / \$18,275	182-42 / \$20,075	\$22,100
WX-456C	187-35 / \$19,200	187-56 / \$21,125	187-41 / \$23,225	187-42 / \$25,550	187-64 / \$28,125
WX-457C	188-35 / \$20,900	188-66 / \$23,000	188-41 / \$25,300	188-42 / \$27,800	188-68 / \$30,625
WX-458C	188-70 / \$23,850	188-79 / \$26,275	\$28,525	\$31,750	*
WX-459C	188-71 / \$27,925	188-97 / \$30,700	\$33,750	188-94 / \$37,125	*
WX-460C	188-72 / \$33,875	\$37,275	\$41,025	\$45,150	*
WX-461C	188-73 / \$37,600	188-91 / \$41,325	\$45,450	\$50,050	*
WX-462C	188-74 / \$56,400	\$62,000	\$68,250	*	*
WX-463C	188-96 / \$99,450	*	*	*	*

* Consult Amtrol Customer Service for List Price and Lead Times.

Standard Leadtime:

WX-421 through WX-427, 100 PSI: 10 days
 WX-447(C) through WX-457(C), 125 & 150 PSI: 10 Days, 175 PSI: 30 Days, 250 PSI: 40 Days,
 300 PSI: 50 Days. WX-458C through WX-463C, All pressures: 50 Days.

Connection (NPTF):

Malleable Iron: WX-421 & WX-422: 2", WX-423 through WX-427: 3", WX-447(C) through WX-452(C): 2",
 WX-453(C) through WX-457(C): 3", WX-458C through WX-463C: 4"

Factory Precharge:

All models: 25 PSI

Warranty:

1-Year Limited

WX-421 THROUGH WX-463C



WX-C (ASME) and WX (NON-ASME) MODELS: FULL ACCEPTANCE BLADDER (continued)

J

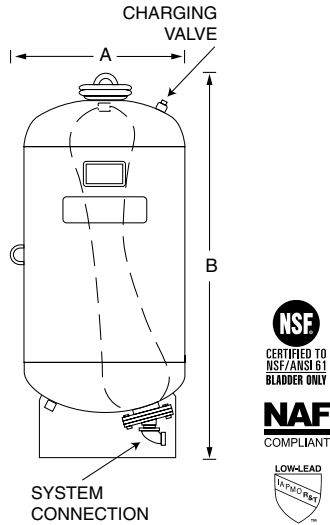

PRICING: NON-ASME MODELS

Base Model Number	Part No. / List Price (USD)	
	100 PSI	150 PSI
WX-421	184-13 / \$8,900	N/A
WX-422	185-13 / \$9,260	N/A
WX-423	186-13 / \$10,775	N/A
WX-424	181-13 / \$11,250	N/A
WX-426	187-13 / \$15,125	N/A
WX-427	188-13 / \$16,325	N/A
WX-447	N/A	183-35 / \$7,210
WX-448	N/A	183-34 / \$7,390
WX-449	N/A	183-33 / \$7,750
WX-450	N/A	183-36 / \$8,000
WX-451	N/A	184-34 / \$9,770
WX-452	N/A	185-34 / \$10,775
WX-453	N/A	186-34 / \$13,125
WX-454	N/A	181-34 / \$13,975
WX-455	N/A	182-34 / \$14,825
WX-456	N/A	187-34 / \$18,850
WX-457	N/A	188-34 / \$20,550

WX-421 THROUGH WX-457

Additional Options: Add to Base Model List Price
Sight Glass (SG): \$320
Seismic Restraints (R): \$225

WX-CL (ASME) and WX-L (NON-ASME) MODELS: PARTIAL ACCEPTANCE BLADDER, 125 PSI

J

TECHNICAL DATA

Base Model Number	Volume (Gal)	Max Acceptance Volume (Gal)	A Diameter (In)	B Height (In)	Shipping Weight (Lbs)
WX-35L(CL)	10	10	10	37	69
WX-50L(CL)	13	11	12	37	76
WX-85L(CL)	22	11	16	35	92
WX-100L(CL)	26	11	16	39	98
WX-130L(CL)	34	27	20	35	136
WX-165L(CL)	44	27	20	40	146
WX-200L(CL)	53	27	24	41	198
WX-300L(CL)	80	27	24	56	236
WX-400L(CL)	106	53	24	69	282
WX-500L(CL)	132	53	24	83	316
WX-600L(CL)	158	53	30	67	450

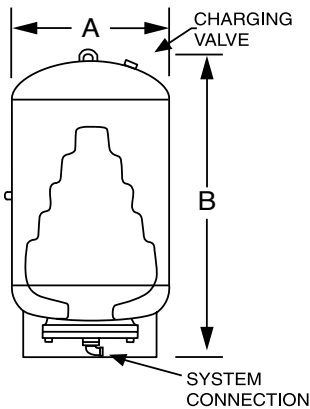

WX-35CL THROUGH WX-600CL

PRICING: ASME MODELS

Base Model Number	Part No. / List Price (USD)
	125 PSI
WX-35CL	165-8 / \$4,550
WX-50CL	166-8 / \$4,609
WX-85CL	167-7 / \$4,739
WX-100CL	168-8 / \$4,778
WX-130CL	169-8 / \$4,979
WX-165CL	171-18 / \$5,040
WX-200CL	191-36 / \$5,210
WX-300CL	192-34 / \$5,450
WX-400CL	193-35 / \$6,370
WX-500CL	194-35 / \$6,590
WX-600CL	174-40 / \$8,350

PRICING: NON-ASME MODELS

Base Model Number	Part No. / List Price (USD)
	125 PSI
WX-35L	165-9 / \$4,472
WX-50L	166-9 / \$4,531
WX-85L	167-8 / \$4,659
WX-100L	168-9 / \$4,698
WX-130L	169-9 / \$4,893
WX-165L	171-19 / \$4,952
WX-200L	191-37 / \$5,130
WX-300L	192-35 / \$5,370
WX-400L	193-36 / \$6,270
WX-500L	194-36 / \$6,470
WX-600L	174-41 / \$8,210

Additional Options: Add to Base Model List Price
Sight Glass (SG): \$320
Seismic Restraints (R): \$225

Standard Leadtime: All models 10 Days
Connection (NPTF): Malleable Iron: WX-35L(CL) through WX-100L(CL): 1-1/4", WX-130L(CL) through WX-300L(CL): 1-1/2", WX-400L(CL) through WX-600L(CL): 2"
Factory Precharge: All models: 25 PSI
Warranty: 1-Year Limited

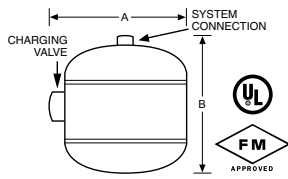
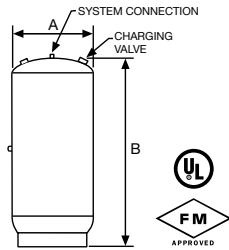
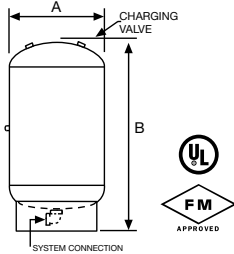

FPT MODELS: FIRE-X-TROL® SPRINKLER SYSTEM EXPANSION TANKS, 175 PSI

F

FPT-1(C) THROUGH FPT-12(C)

FPT-20V(C) THROUGH FPT-70V(C)

FPT-80V(C) THROUGH FPT-210V(C)

Operating Temperature Range:
-20° F to 200° F

TECHNICAL DATA

Model Number	Volume (Gal)	Max Acceptance Volume (Gal)	A Diameter (In)	B Height (In)	Sys. Conn. (In) St. Steel NPTF	Shipping Weight (Lbs)
FPT-1(C)	1.5	0.7	8	9	3/4	16
FPT-5(C)	2.1	0.9	10	10	3/4	21
FPT-12(C)	6.4	3.2	12	16	3/4	36
FPT-20V(C)	8.0	3.2	12	20	3/4	52
FPT-30V(C)	14.0	9.0	16	19	3/4	97
FPT-42V(C)	17.5	11.0	16	24	3/4	116
FPT-60V(C)	25.0	11.0	16	33	3/4	154
FPT-70V(C)	34.0	11.0	16	42	3/4	197
FPT-80V(C)	53.0	35.0	24	36	1 1/4	251
FPT-120V(C)	66.0	35.0	24	44	1 1/4	281
FPT-180V(C)	77.0	35.0	24	49	1 1/4	353
FPT-210V(C)	90.0	35.0	24	56	1 1/4	382

PRICING: ASME MODELS

Model Number	Part No. / List Price (USD)	175 PSI
FPT-1C	140-757 / \$1,425	
FPT-5C	140-746 / \$1,932	
FPT-12C	141-370 / \$2,497	
FPT-20VC	142-183 / \$3,341	
FPT-30VC	143-373 / \$3,834	
FPT-42VC	144-259 / \$4,928	
FPT-60VC	146-809 / \$6,850	
FPT-70VC	146-810 / \$9,320	
FPT-80VC	147-229 / \$10,050	
FPT-120VC	147-230 / \$10,625	
FPT-180VC	148-161 / \$11,200	
FPT-210VC	148-162 / \$13,400	

PRICING: NON-ASME MODELS

Model Number	Part No. / List Price (USD)	175 PSI
FPT-1	140-756 / \$1,425	
FPT-5	140-748 / \$1,932	
FPT-12	141-374 / \$2,497	
FPT-20V	142-184 / \$3,341	
FPT-30V	143-378 / \$3,834	
FPT-42V	144-263 / \$4,928	
FPT-60V	146-813 / \$6,850	
FPT-70V	146-814 / \$9,320	
FPT-80V	147-235 / \$10,050	
FPT-120V	147-236 / \$10,625	
FPT-180V	148-164 / \$11,200	
FPT-210V	148-165 / \$13,400	

Seismic Restraints (R) Standard; Sight Glass (SG) Available on Models FPT-20V(C) through FPT-210V(C)

SPT MODELS: SURGE-TROL® SPRINKLER SYSTEM SURGE SUPPRESSORS, 275 PSI

F

TECHNICAL DATA

Model Number	Volume (Gal)	A Diameter (In)	B Height (In)	Sys. Conn. (In)	Shipping Weight (Lbs)
SPT-1	10	16	31	4	200
SPT-3	25	16	49	4	273
SPT-7	53	24	49	4	390
SPT-11	80	24	63	4	505
SPT-14	106	24	77	4	618
SPT-18	132	24	91	4	731
SPT-21	158	30	75	4	950
SPT-28	211	30	93	4	1,125
SPT-35	264	36	85	6	1,520
SPT-42	317	36	97	6	1,720
SPT-50	370	36	110	6	1,900
SPT-56	422	48	86	8	2,300
SPT-70	528	48	100	8	2,700

PRICING: ASME MODELS

Model Number	Part No. / List Price (USD)	275 PSI
SPT-1	217-012 / \$14,900	
SPT-3	217-013 / \$20,800	
SPT-7	217-001 / \$22,575	
SPT-11	217-002 / \$22,750	
SPT-14	217-003 / \$23,300	
SPT-18	217-004 / \$23,600	
SPT-21	217-005 / \$31,925	
SPT-28	217-006 / \$35,300	

Model Number	Part No. / List Price (USD)	275 PSI
SPT-35	217-007 / \$45,575	
SPT-42	217-008 / \$48,275	
SPT-50	217-009 / \$50,950	
SPT-56	217-010 / \$59,000	
SPT-70	217-011 / \$61,900	

Additional Options: Add to Base Model List Price
Sight Glass (SG): \$320
Seismic Restraints (R): \$225

Maximum Operating Temperature: 240° F

Seismic Restraints (R) Standard; Sight Glass (SG) Optional

Standard Leadtime: FPT Models: 10 Days, SPT Models: 30 Days
Connection: 275 PSI: 300# flange.
Warranty: 1-Year Limited

www.amtrol.com

Effective January 2, 2017

D MODELS: DIATROL® SHOCK SUPPRESSORS, 250 PSI, ASME

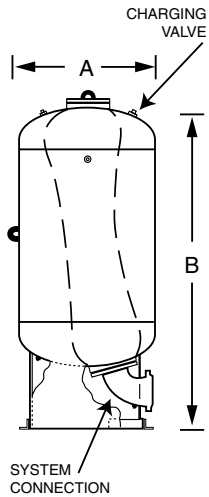
J

TECHNICAL DATA

Model Number	Volume (Gal)	A Diameter (In)	B Height (In)	Sys. Conn. (In)	Shipping Weight (Lbs)
D-7	53	24	49	4	390
D-11	80	24	63	4	505
D-14	106	24	77	4	618
D-18	132	24	91	4	731
D-21	158	30	75	4	950
D-28	211	30	93	4	1,125
D-35	264	36	85	6	1,520
D-42	317	36	97	6	1,720
D-50	370	36	110	6	1,900
D-56	422	48	86	8	2,300
D-70	528	48	100	8	2,700

PRICING: ASME MODELS

Model Number	Part No. / List Price (USD) 250 PSI
D-7	183-39 / \$15,500
D-11	183-37 / \$15,700
D-14	183-44 / \$16,150
D-18	183-42 / \$16,550
D-21	184-52 / \$25,150
D-28	184-57 / \$27,975
D-35	186-47 / \$39,125
D-42	186-57 / \$41,900
D-50	186-56 / \$44,700
D-56	187-53 / \$53,100
D-70	188-50 / \$55,950

D-7 THROUGH D-70



Maximum Operating Temperature: 200° F

Seismic Restraints (R) Standard & Sight Glass (SG) Optional

For water hammer reduction in potable cold or hot water systems.
Standard Leadtime: All Models: 30 Days

Warranty: 1-Year Limited

Additional Options: Add to Base Model List Price

Sight Glass (SG): \$320

Connection: 250 PSI: 300# flange.

REPLACEMENT BLADDERS

J

EXTROL® REPLACEMENT BLADDERS

Model Number	Application	Shipping Weight (Lbs)	List Price (USD)
191-3	200-L	15	\$2,267
192-3	300-L	20	\$2,393
193-3	400-L	25	\$2,512
194-3	500-L	30	\$2,595
174-16	600-L	33	\$2,685
175-15	800-L	35	\$2,773
176-15	1000-L	37	\$3,409
177-15	1200-L	43	\$3,534
178-15	1400-L	52	\$3,941
179-15	1600-L	55	\$4,130
180-15	2000-L	63	\$4,210
180-35	2500-L	71	\$4,507
180-36	3000-L	82	\$5,280
180-37	3500-L	102	\$7,190
180-38	4000-L	109	\$8,860
180-48	5000-L	128	\$10,450
180-90	7500-L	155	\$11,675
180-91	10000-L	225	\$15,925
180-92	15000-L	310	\$26,525
10-0001	35-100LBC	13	\$975
10-0002	130-300LBC	19	\$1,320
10-0003	400-600LBC	33	\$1,868

THERM-X-TROL® & WELL-X-TROL® REPLACEMENT BLADDERS

Model Number	Application	Shipping Weight (Lbs)	List Price (USD)
183-10	WX & ST-447	16	\$2,600
183-11	WX & ST 448	21	\$2,681
183-12	WX & ST-449	26	\$2,738
183-13	WX & ST-450	31	\$2,749
184-27	WX & ST-451/421	26	\$2,853
185-22	WX & ST-452/422	32	\$2,949
186-23	WX & ST-453/423	37	\$3,740
181-21	WX & ST-454/424	42	\$3,783
182-21	WX & ST-455	48	\$4,253
187-21	WX & ST-456/426	52	\$4,364
188-21	WX & ST-457/427	62	\$4,519
188-80	WX458	71	\$5,730
188-81	WX459	82	\$6,030
188-82	WX460	102	\$8,110
188-83	WX461	109	\$8,700
188-84	WX462	128	\$9,980
188-85	WX463	150	\$13,900
10-0004	ST35-100(C)L	13	\$3,028
10-0005	ST130-300(C)L	19	\$3,999
10-0006	ST400-600(C)L	33	\$4,760
10-0007	WX35-100(C)L	13	\$3,028
10-0008	WX130-300(C)L	19	\$3,999
10-0009	WX400-600(C)L	33	\$4,760



DIATROL® & SURGE-TROL® REPLACEMENT BLADDERS

Model Number	Application	Shipping Weight (Lbs)	List Price (USD)
183-77	D & SPT-7	15	\$2,403
183-72	D & SPT-11	20	\$2,536
183-73	D & SPT-14	25	\$2,664
183-74	D & SPT-18	30	\$2,749
183-75	D & SPT-21	33	\$2,853
183-76	D & SPT-28	35	\$2,949
181-56	D & SPT-35	37	\$3,740
181-57	D & SPT-42	43	\$3,783
181-58	D & SPT-50	52	\$4,253
187-59	D & SPT-56	55	\$4,364
187-60	D & SPT-70	63	\$4,711



Standard Leadtime:
Warranty:

Extrol, Therm-X-Trol & Well-X-Trol Bladders: 10 Days, Diatrol & Surge-Trol Bladders: 40 Days
1-Year Limited



Index

1-ASL.....	20	165-LBC.....	19	443-1.....	13	940R2.....	14
2 1/2-AS.....	21	174-16.....	34	444-1.....	13	940R101.....	14
2 1/2-ASL.....	20	175-15.....	34	445-1.....	13	1000-L.....	18
2-ADS.....	22	176-15.....	34	446-1.....	13	1200-L.....	18
2-AS.....	21	177-15.....	34	447-1.....	13	1400-L.....	18
2-ASL.....	20	178-15.....	34	448-1.....	13	1600-L.....	18
3-ADS.....	22	179-15.....	34	449.....	22	2000-L.....	18
3-AS.....	21	180-15.....	34	461.....	22	2201N002.....	9
3-ASL.....	20	180-35.....	34	462.....	22	2201N003.....	9
4-ADS.....	22	180-36.....	34	463.....	22	2201N006.....	9
4-AS.....	21	180-37.....	34	464.....	22	2201N010.....	9
4-ASL.....	20	180-38.....	34	465.....	22	2201N020.....	9
5-ADS.....	22	180-48.....	34	466.....	22	2201N021.....	9
5-AS.....	21	180-90.....	34	467.....	22	2201N022.....	9
5-ASL.....	20	180-91.....	34	468.....	22	2201R28.....	9
6-ADS.....	22	180-92.....	34	500-L.....	18	2201R37.....	9
6-AS.....	21	181-21.....	34	500-LBC.....	19	2201R39.....	9
6-ASL.....	20	181-56.....	34	513P01.....	10	2500-178.....	14
8-ADS.....	22	181-57.....	34	537-1.....	10	2500-218.....	14
8-AS.....	21	181-58.....	34	541-1.....	10	2500-L.....	18
8-ASL.....	20	182-21.....	34	600-L.....	18	2700-635.....	14
10-0001.....	34	183-10.....	34	600-LBC.....	19	2700-924.....	14
10-0002.....	34	183-11.....	34	601-1.....	11	2700-5000.....	14
10-0003.....	34	183-12.....	34	601-2.....	11	2700-5001.....	14
10-0004.....	34	183-13.....	34	601-3.....	11	2700-5002.....	14
10-0005.....	34	183-72.....	34	601-4.....	11	2700-5003.....	14
10-0006.....	34	183-73.....	34	601-5.....	11	2700-5005.....	14
10-0007.....	34	183-74.....	34	601-6.....	11	2700-5006.....	14
10-0008.....	34	183-75.....	34	602-1.....	11	2700-5008.....	14
10-0009.....	34	183-76.....	34	602-2.....	11	2700R1106.....	14
10-ADS.....	22	183-77.....	34	602-3.....	11	2702R001.....	14
10-AS.....	21	184-27.....	34	602-4.....	11	2702R002.....	14
10-ASL.....	20	185-22.....	34	602-5.....	11	2703R001.....	14
12-ADS.....	22	186-23.....	34	602-6.....	11	2703R003.....	14
12-AS.....	21	187-21.....	34	602-7.....	11	2704-093.....	14
12-ASL.....	20	187-59.....	34	602-8.....	11	2704-259.....	14
14-AS.....	21	187-60.....	34	603-1.....	11	2704-392.....	14
14-ASL.....	20	188-21.....	34	603-2.....	11	2704-487.....	14
16-AS.....	21	188-80.....	34	603-3.....	11	2704-529.....	14
16-ASL.....	20	188-81.....	34	603-4.....	11	2704R512.....	14
18-AS.....	21	188-82.....	34	603-5.....	11	2712R002.....	14
18-ASL.....	20	188-83.....	34	603-6.....	11	2713R002.....	14
20-AS.....	21	188-84.....	34	603-7.....	11	2770-133.....	14
20-ASL.....	20	188-85.....	34	603-8.....	11	2775-82.....	14
22-AS.....	21	191-3.....	34	604-1.....	11	2775-83.....	14
22-ASL.....	20	192-3.....	34	604-2.....	11	2775-84.....	14
24-AS.....	21	193-3.....	34	604-3.....	11	2775-454.....	14
24-ASL.....	20	194-3.....	34	604-4.....	11	2775-455.....	14
35-LBC.....	19	200-L.....	18	606-2.....	11	2775-768.....	14
50-LBC.....	19	200-LBC.....	19	606-3.....	11	2782R0002.....	14
85-LBC.....	19	245-59.....	9	606-4.....	11	2783R0001.....	14
100-LBC.....	19	245-60.....	9	608-4.....	11	2783R0004.....	14
113-3.....	9	245-61.....	9	608-6.....	11	3000-L.....	18
130-LBC.....	19	300-L.....	18	608-7.....	11	3500-L.....	18
140-127.....	8	300-LBC.....	19	608-8.....	11	4000-L.....	18
140-470.....	13	400-L.....	18	700-C.....	13	5000-L.....	18
146-832.....	8, 9	400-LBC.....	19	700-QC.....	13	7500-L.....	18
146-2350.....	8	420-1.....	13	701-C.....	13	9340R160.....	14
		420-6.....	13	747.....	23	10000-L.....	18
		421-1.....	13	800-L.....	18	15000-L.....	18

AC12-15.....	23	CH-80ZDW-R.....	14	EX-3000-125.....	12	PL-81.....	7
AC12-24.....	23	CH-80Z-G.....	14	FPT-1(C).....	32	PL-86.....	7
AC14-30.....	23	CH-80Z-R.....	14	FPT-5(C).....	32	PL-119.....	7
AC14-40.....	23	CH-81.....	6	FPT-12(C).....	32	Repair Kit.....	23
AC16-60.....	23	CH-86.....	6	FPT-20V(C).....	32	RO-2.....	7
AC20-80.....	23	CH-119.....	6	FPT-30V(C).....	32	RO-3.....	7
AC20-100.....	23	CWBT120-3.....	24	FPT-42V(C).....	32	RO-4.....	7
AC24-120.....	23	CWBT120-4.....	24	FPT-60V(C).....	32	RO-10.....	7
AC24-135.....	23	CWBT120-6.....	24	FPT-70V(C).....	32	RO-14.....	7
AC30-175.....	23	CWBT200-3.....	24	FPT-80V(C).....	32	RO-20.....	7
AC30-220.....	23	CWBT200-4.....	24	FPT-120V(C).....	32	RO-20PA.....	7
AC30-240.....	23	CWBT200-6.....	24	FPT-180V(C).....	32	RO-34.....	7
AC30-305.....	23	CWBT300-3.....	24	FPT-210V(C).....	32	RO-34PA.....	7
AC36-400.....	23	CWBT300-4.....	24	FT-15.....	12	RO-44.....	7
AC36-505.....	23	CWBT300-6.....	24	FT-30.....	12	RO-44PA.....	7
AX-15.....	16	CWBT300-8.....	24	FT-109.....	12	RO-86.....	7
AX-15V.....	17	CWBT500-6.....	24	FT-109-15.....	12	RO-86PA.....	7
AX-20.....	16	CWBT500-8.....	24	FT-109-100.....	12	RO-119PA.....	7
AX-20V.....	17	CWBT500-10.....	24	FT-109-125.....	12	RP-10HP.....	9
AX-40.....	16	CWBT850-6.....	24	FT-110.....	12	RP-15HP.....	9
AX-40V.....	17	CWBT850-8.....	24	FT-110-100.....	12	RP-25HP.....	9
AX-60.....	16	CWBT850-10.....	24	FT-110-125.....	12	RX-15.....	13
AX-60V.....	17	CWBT1040-8.....	24	FT-111.....	12	RX-30.....	13
AX-80.....	16	CWBT1040-10.....	24	FT-111-125.....	12	RX-60.....	13
AX-80V.....	17	CWBT1040-12.....	24	FT-112.....	12	S-41.....	15
AX-100.....	16	D-7.....	33	HM-41L.....	14	S-41L.....	15
AX-100V.....	17	D-11.....	33	HM-41LDW.....	14	S-80.....	15
AX-120.....	16	D-14.....	33	HM-41Z.....	14	S-80L.....	15
AX-120V.....	17	D-18.....	33	HM-41ZDW.....	14	S-120.....	15
AX-144.....	16	D-21.....	33	HM-80L.....	14	S-120L.....	15
AX-144V.....	17	D-28.....	33	HM-80LDW.....	14	SE-15.....	13
AX-180.....	16	D-35.....	33	HM-80Z.....	14	SE-30.....	13
AX-180V.....	17	D-42.....	33	HM-80ZDW.....	14	SE-60.....	13
AX-200.....	16	D-50.....	33	HWBT120-2.....	25	SPT-1.....	32
AX-200V.....	17	D-56.....	33	HWBT120-2/2.....	25	SPT-3.....	32
AX-240.....	16	D-70.....	33	HWBT120-2/3.....	25	SPT-7.....	32
AX-240V.....	17	DC-80.....	15	HWBT120-3.....	25	SPT-11.....	32
AX-260.....	16	DC-80DW.....	15	HWBT120-3/3.....	25	SPT-14.....	32
AX-260V.....	17	DC-120.....	15	HWBT120-4/4.....	25	SPT-18.....	32
AX-280.....	16	DC-120DW.....	15	HWBT120-6/6.....	25	SPT-21.....	32
AX-280V.....	17	DURABASE-15.....	8	HWBT200-2.....	25	SPT-28.....	32
CH-14.....	6	DURABASE-22.....	8	HWBT200-2/2.....	25	SPT-35.....	32
CH-20.....	6	ERTG-12A.....	8	HWBT200-2/3.....	25	SPT-42.....	32
CH-26.....	6	ERTG-21A.....	8	HWBT200-3.....	25	SPT-50.....	32
CH-32.....	6	ERTG-30A.....	8	HWBT200-3/3.....	25	SPT-56.....	32
CH-34.....	6	ERTG-42SA.....	8	HWBT200-4/4.....	25	SPT-70.....	32
CH-41Z-B.....	14	ERTG-42TA.....	8	HWBT300-2.....	25	ST-5.....	10
CH-41ZCT-B.....	14	ERTG-82A.....	8	HWBT300-2/2.....	25	ST-5C.....	26
CH-41ZCT-G.....	14	ERTG-120A.....	8	HWBT300-2/3.....	25	ST-5-FF.....	10
CH-41ZCT-R.....	14	ERTG-220A.....	8	HWBT300-2.5.....	25	ST-8.....	10
CH-41ZDW-B.....	14	ERTG-315A.....	8	HWBT300-3.....	25	ST-12.....	10
CH-41ZDW-G.....	14	EX-15.....	12	HWBT300-3/3.....	25	ST-12C.....	26
CH-41ZDW-R.....	14	EX-15-FF.....	12	HWBT300-4/4.....	25	ST-12-FF.....	10
CH-41Z-G.....	14	EX-30.....	12	PL-14.....	7	ST-20VC.....	26
CH-41Z-R.....	14	EX-30-FF.....	12	PL-20.....	7	ST-25V.....	10
CH-44.....	6	EX-60.....	12	PL-26.....	7	ST-30V.....	10
CH-62.....	6	EX-90.....	12	PL-32.....	7	ST-30VC.....	26
CH-80Z-B.....	14	EX-1500-100.....	12	PL-34.....	7	ST-35L(CL).....	28
CH-80ZDW-B.....	14	EX-1500-125.....	12	PL-44.....	7	ST-42V.....	10
CH-80ZDW-G.....	14	EX-3000-100.....	12	PL-62.....	7	ST-42VC.....	26



ST-50L(CL).....	28	WH-41L-G.....	14	WX-202H.....	5	WX-255PA.....	4
ST-60V.....	10	WH-41L-R.....	14	WX-202PA.....	4	WX-255PA-G.....	4
ST-60VC.....	26	WH-41Z-B.....	14	WX-202PA-G.....	4	WX-255PA-T.....	4
ST-70VC.....	26	WH-41ZDW-B.....	14	WX-202PA-T.....	4	WX-255-T.....	4
ST-80V.....	10	WH-41ZDW-G.....	14	WX-202PS.....	5	WX-300L(CL).....	31
ST-80VC.....	26	WH-41Z-G.....	14	WX-202-T.....	4	WX-302.....	4
ST-85L(CL).....	28	WH-41Z-R.....	14	WX-202UG.....	6	WX-302D.....	5
ST-100L(CL).....	28	WHS-60L.....	15	WX-202XL.....	4	WX-302D-G.....	5
ST-120VC.....	26	WHS-60LDW.....	15	WX-202XLD.....	5	WX-302D-T.....	5
ST-130L(CL).....	28	WHS-60Z.....	15	WX-202XLD-G.....	5	WX-302-G.....	4
ST-165L(CL).....	28	WHS-60ZC.....	15	WX-202XLD-T.....	5	WX-302PA.....	4
ST-180V.....	10	WHS-60ZCDW.....	15	WX-202XL-G.....	4	WX-302PA-G.....	4
ST-180VC.....	26	WHS-60ZDW.....	15	WX-202XLPA.....	4	WX-302PA-T.....	4
ST-200L(CL).....	28	WHS-80L.....	15	WX-202XLPA-G.....	4	WX-302-T.....	4
ST-200V.....	10	WHS-80LDW.....	15	WX-202XLPA-T.....	4	WX-350.....	4
ST-210V.....	10	WHS-80Z.....	15	WX-202XL-T.....	4	WX-350D.....	5
ST-210VC.....	26	WHS-80ZC.....	15	WX-203.....	4	WX-350D-G.....	5
ST-300L(CL).....	28	WHS-80ZCDW.....	15	WX-203D.....	5	WX-350D-T.....	5
ST-400L(CL).....	28	WHS-80ZDW.....	15	WX-203D-G.....	5	WX-350-G.....	4
ST-447C.....	27	WHS-120L.....	15	WX-203D-T.....	5	WX-350PA.....	4
ST-448C.....	27	WHS-120Z.....	15	WX-203-G.....	4	WX-350PA-G.....	4
ST-449C.....	27	WHS-120ZC.....	15	WX-203PA.....	4	WX-350PA-T.....	4
ST-450C.....	27	WHS-120ZCDW.....	15	WX-203PA-G.....	4	WX-350-T.....	4
ST-451(C).....	27	WX1-250D.....	6	WX-203PA-T.....	4	WX-400L(CL).....	31
ST-452(C).....	27	WX1-251D.....	6	WX-203-T.....	4	WX-401(C).....	29
ST-453(C).....	27	WX1-302D.....	6	WX-205.....	4	WX-402(C).....	29
ST-454(C).....	27	WX-35L(CL).....	31	WX-205D.....	5	WX-403(C).....	29
ST-455(C).....	27	WX-50L(CL).....	31	WX-205D-G.....	5	WX-404(C).....	29
ST-456(C).....	27	WX-85L(CL).....	31	WX-205D-T.....	5	WX-405(C).....	29
ST-457(C).....	27	WX-100L(CL).....	31	WX-205-G.....	4	WX-406(C).....	29
ST-500L(CL).....	28	WX-101.....	5	WX-205PA.....	4	WX-407(C).....	29
ST-600L(CL).....	28	WX-101-G.....	5	WX-205PA-G.....	4	WX-421.....	30
SX-30V.....	12	WX-102.....	5	WX-205PA-T.....	4	WX-422.....	30
SX-40V.....	12	WX-102-G.....	5	WX-205-T.....	4	WX-423.....	30
SX-60V.....	12	WX-102PS.....	5	WX-250.....	4	WX-424.....	30
SX-90V.....	12	WX-102VFD.....	5	WX-250D.....	5	WX-426.....	30
SX-110V.....	12	WX-103.....	5	WX-250D-G.....	5	WX-427.....	30
SX-130V.....	12	WX-103-G.....	5	WX-250D-T.....	5	WX-447(C).....	30
SX-160V.....	12	WX-104.....	5	WX-250-G.....	4	WX-448(C).....	30
T-5.....	10	WX-104-G.....	5	WX-250PA.....	4	WX-449(C).....	30
T-5-FF.....	10	WX-105PS.....	5	WX-250PA-G.....	4	WX-450(C).....	30
T-12.....	10	WX-110PS.....	5	WX-250PA-T.....	4	WX-451(C).....	30
T-12-FF.....	10	WX-130L(CL).....	31	WX-250-T.....	4	WX-452(C).....	30
UNVDKT.....	8	WX-165L(CL).....	31	WX-250UG.....	6	WX-453(C).....	30
WF-14.....	6	WX-200.....	5	WX-251.....	4	WX-454(C).....	30
WF-20.....	6	WX-200-G.....	5	WX-251D.....	5	WX-455(C).....	30
WF-26.....	6	WX-200L(CL).....	31	WX-251D-G.....	5	WX-456(C).....	30
WF-32.....	6	WX-200PS.....	5	WX-251D-T.....	5	WX-457(C).....	30
WF-34.....	6	WX-200UG.....	6	WX-251-G.....	4	WX-458C.....	30
WF-44.....	6	WX-201.....	4	WX-251PA.....	4	WX-459C.....	30
WF-62.....	6	WX-201D.....	5	WX-251PA-G.....	4	WX-460C.....	30
WF-81.....	6	WX-201D-G.....	5	WX-251PA-T.....	4	WX-461C.....	30
WF-86.....	6	WX-201D-T.....	5	WX-251-T.....	4	WX-462C.....	30
WF-119.....	6	WX-201-G.....	4	WX-251UG.....	6	WX-463C.....	30
WH-7C.....	15	WX-201-T.....	4	WX-252.....	4	WX-500L(CL).....	31
WH-7CDW.....	15	WX-202.....	4	WX-255.....	4	WX-600L(CL).....	31
WH-7ZC.....	15	WX-202D.....	5	WX-255D.....	5		
WH-41L-B.....	14	WX-202D-G.....	5	WX-255D-G.....	5		
WH-41LDW-B.....	14	WX-202D-T.....	5	WX-255D-T.....	5		
WH-41LDW-G.....	14	WX-202-G.....	4	WX-255-G.....	4		

AX Models: Horizontal Diaphragm Type, ASME

Base Model	Part No.	Seismic Restraints	Part No.	Sight Glass	Part No.	Sight Glass & Restraints	Part No.
AX15-125	117-0015	AX15-125R	117-0019	AX15-125SG	117-0026	AX15-125SGR	117-235
AX20-125	117-0020	AX20-125R	117-0028	AX20-125SG	117-0029	AX20-125SGR	117-0030
AX40-125	117-0040	AX40-125R	117-0048	AX40-125SG	117-0049	AX40-125SGR	117-434
AX60-125	117-0060	AX60-125R	117-0070	AX60-125SG	117-0071	AX60-125SGR	117-0072
AX80-125	117-80	AX80-125R	117-86	AX80-125SG	117-87	AX80-125SGR	117-88
AX100-125	117-100	AX100-125R	117-106	AX100-125SG	117-107	AX100-125SGR	117-108
AX120-125	117-120	AX120-125R	117-127	AX120-125SG	117-128	AX120-125SGR	117-143
AX144-125	117-144	AX144-125R	117-153	AX144-125SG	117-154	AX144-125SGR	117-155
AX180-125	117-180	AX180-125R	117-188	AX180-125SG	117-189	AX180-125SGR	117-190
AX200-125	117-200	AX200-125R	117-206	AX200-125SG	117-207	AX200-125SGR	117-232
AX240-125	117-408	AX240-125R	117-409	AX240-125SG	117-411	AX240-125SGR	N/A
AX260-125	117-420	AX260-125R	117-422	AX260-125SG	117-423	AX260-125SGR	N/A
AX280-125	117-430	AX280-125R	117-432	AX280-125SG	117-433	AX280-125SGR	N/A

AX-V Models: Vertical Diaphragm Type, ASME

Base Model	Part No.	Seismic Restraints	Part No.	Sight Glass	Part No.	Sight Glass & Restraints	Part No.
AX15V-125	117-401	AX15V-125R	117-439	AX15V-125SG	117-407	AX15V-125SGR	117-536
AX20V-125	117-402	AX20V-125R	117-236	AX20V-125SG	117-406	AX20V-125SGR	N/A
AX40V-125	117-403	AX40V-125R	117-416	AX40V-125SG	117-405	AX40V-125SGR	117-417
AX60V-125	117-0062	AX60V-125R	117-346	AX60V-125SG	117-0074	AX60V-125SGR	117-578
AX80V-125	117-81	AX80V-125R	117-275	AX80V-125SG	117-90	AX80V-125SGR	117-277
AX100V-125	117-101	AX100V-125R	117-840	AX100V-125SG	117-110	AX100V-125SGR	117-942
AX120V-125	117-121	AX120V-125R	117-345	AX120V-125SG	117-131	AX120V-125SGR	117-220
AX144V-125	117-145	AX144V-125R	117-438	AX144V-125SG	117-151	AX144V-125SGR	N/A
AX180V-125	117-181	AX180V-125R	117-404	AX180V-125SG	117-192	AX180V-125SGR	117-606
AX200V-125	117-201	AX200V-125R	117-347	AX200V-125SG	117-210	AX200V-125SGR	117-564
AX240V-125	117-281	AX240V-125R	117-885	AX240V-125SG	117-412	AX240V-125SGR	117-414
AX260V-125	117-421	AX260V-125R	117-440	AX260V-125SG	117-442	AX260V-125SGR	N/A
AX280V-125	117-431	AX280V-125R	117-441	AX280V-125SG	117-437	AX280V-125SGR	117-577

L Models: Full Acceptance Bladder, Top Connection, ASME

Base Model	Part No.	Seismic Restraints	Part No.	Sight Glass	Part No.	Sight Glass & Restraints	Part No.
200L-125	191-2	200L-125R	191-6	200L-125SG	191-15	200L-125SGR	191-7
300L-125	192-2	300L-125R	192-29	300L-125SG	192-15	300L-125SGR	192-30
400L-125	193-2	400L-125R	193-30	400L-125SG	193-15	400L-125SGR	193-43
500L-125	194-2	500L-125R	194-6	500L-125SG	194-15	500L-125SGR	194-5
600L-125	174-2	600L-125R	174-32	600L-125SG	174-8	600L-125SGR	174-37
800L-125	175-2	800L-125R	175-35	800L-125SG	175-8	800L-125SGR	175-36
1000L-125	176-2	1000L-125R	176-30	1000L-125SG	176-7	1000L-125SGR	176-33
1200L-125	177-2	1200L-125R	177-31	1200L-125SG	177-7	1200L-125SGR	177-24
1400L-125	178-2	1400L-125R	178-31	1400L-125SG	178-8	1400L-125SGR	178-33
1600L-125	179-2	1600L-125R	179-30	1600L-125SG	179-7	1600L-125SGR	179-33
2000L-125	180-2	2000L-125R	180-31	2000L-125SG	180-7	2000L-125SGR	180-16
2500L-125	180-33	2500L-125R	180-47	2500L-125SG	N/A	2500L-125SGR	180-126
3000L-125	180-34	3000L-125R	180-54	3000L-125SG	180-86	3000L-125SGR	N/A
3500L-125	189-1	3500L-125R	189-22	3500L-125SG	N/A	3500L-125SGR	N/A
4000L-125	189-2	4000L-125R	189-28	4000L-125SG	189-36	4000L-125SGR	N/A
5000L-125	189-3	5000L-125R	N/A	5000L-125SG	N/A	5000L-125SGR	N/A

FREQUENTLY USED PART NUMBERS

LBC Models: Partial Acceptance Bladder, Bottom Connection, ASME

Base Model	Part No.	Seismic Restraints	Part No.	Sight Glass	Part No.	Sight Glass & Restraints	Part No.
35LBC-125	165-5	35LBC-125R	165-13	35LBC-125SG	165-11	35LBC-125SGR	165-15
50LBC-125	166-5	50LBC-125R	166-12	50LBC-125SG	166-11	50LBC-125SGR	166-14
85LBC-125	167-4	85LBC-125R	167-11	85LBC-125SG	N/A	85LBC-125SGR	167-12
100LBC-125	168-4	100LBC-125R	168-7	100LBC-125SG	168-11	100LBC-125SGR	N/A
130LBC-125	169-4	130LBC-125R	169-7	130LBC-125SG	169-10	130LBC-125SGR	169-11
165LBC-125	171-15	165LBC-125R	171-21	165LBC-125SG	N/A	165LBC-125SGR	N/A
200LBC-125	191-33	200LBC-125R	191-41	200LBC-125SG	191-39	200LBC-125SGR	191-45
300LBC-125	192-31	300LBC-125R	192-37	300LBC-125SG	192-38	300LBC-125SGR	N/A
400LBC-125	193-32	400LBC-125R	193-37	400LBC-125SG	193-40	400LBC-125SGR	N/A
500LBC-125	194-32	500LBC-125R	N/A	500LBC-125SG	N/A	500LBC-125SGR	194-42
600LBC-125	174-36	600LBC-125R	174-42	600LBC-125SG	N/A	600LBC-125SGR	N/A

ST Models: Diaphragm Type, ASME

Base Model	Part No.	Seismic Restraints	Part No.	Sight Glass	Part No.	Sight Glass & Restraints	Part No.
ST20VC-150	142-149	ST20VC-150R	142-156	ST20VC-150SG	142-134	ST20VC-150SGR	N/A
ST30VC-150	143-327	ST30VC-150R	143-364	ST30VC-150SG	143-269	ST30VC-150SGR	N/A
ST42VC-150	144-207	ST42VC-150R	144-229	ST42VC-150SG	144-179	ST42VC-150SGR	N/A
ST60VC-150	146-776	ST60VC-150R	146-796	ST60VC-150SG	146-759	ST60VC-150SGR	N/A
ST70VC-150	146-790	ST70VC-150R	146-822	ST70VC-150SG	146-808	ST70VC-150SGR	N/A
ST80VC-150	147-139	ST80VC-150R	147-202	ST80VC-150SG	147-141	ST80VC-150SGR	147-194
ST120VC-150	147-199	ST120VC-150R	147-218	ST120VC-150SG	N/A	ST120VC-150SGR	N/A
ST180VC-150	148-109	ST180VC-150R	148-156	ST180VC-150SG	148-120	ST180VC-150SGR	N/A
ST210VC-150	148-110	ST210VC-150R	148-166	ST210VC-150SG	148-116	ST210VC-150SGR	N/A

WELL-X-TROL® Quick Sizing

Pump Discharge Rate (Approx. GPM)	OPERATING PRESSURE					
	30/50 PSIG		40/60 PSIG		50/70 PSIG	
	ESP I	ESP II	ESP I	ESP II	ESP I	ESP II
5	WX-202	WX-205	WX-202	WX-205	WX-202	WX-250
7	WX-202XL	WX-250	WX-203	WX-251	WX-203	WX-251
10	WX-205	WX-251	WX-205	WX-255	WX-250	WX-302
12	WX-250	WX-255	WX-250	WX-255	WX-251	WX-350
15	WX-250	WX-302	WX-251	WX-350	WX-251	WX-350
20	WX-251	WX-350	WX-255	WX-255 (2)	WX-302	WX-302 (2)
25	WX-255	WX-255 (2)	WX-302	WX-302 (2)	WX-350	WX-350 (2)
30	WX-302	WX-302 (2)	WX-350	WX-350 (2)	WX-350	WX-302 (3)
35	WX-350	WX-350 (2)	WX-350	WX-350 (2)	WX-255 (2)	WX-350 (3)
40	WX-350	WX-350 (2)	WX-255 (2)	WX-302 (3)	WX-302 (2)	WX-350 (3)

ESP I - Effective Sizing Protection I: The tank selection is based on approximately one minute running time. This is recommended for pumps up to 3/4 hp.
 ESP II - Effective Sizing Protection II: The tank selection is based on approximately two minutes running time. This is recommended for pumps 3/4 hp or larger.

THERM-X-TROL® Quick Sizing

Maximum Temperature Setting 140°F				Maximum Temperature Setting 160°F				Maximum Temperature Setting 180°F			
Water Heater Size (gals.)	Static Supply Pressure (psig)			Water Heater Size (gals.)	Static Supply Pressure (psig)			Water Heater Size (gals.)	Static Supply Pressure (psig)		
	40	60	80		40	60	80		40	60	80
40	ST-5	ST-5	ST-5	40	ST-5	ST-5	ST-8	40	ST-8	ST-8	ST-8
50	ST-5	ST-5	ST-5	50	ST-5	ST-8	ST-8	50	ST-8	ST-8	ST-12
60	ST-8	ST-8	ST-8	60	ST-8	ST-8	ST-12	60	ST-8	ST-12	ST-25V
80	ST-8	ST-8	ST-12	80	ST-8	ST-12	ST-25V	80	ST-12	ST-25V	ST-25V
120	ST-12	ST-12	ST-25V	120	ST-12	ST-25V	ST-25V	120	ST-25V	ST-25V	ST-25V

Sizing based on: 40°F incoming water temperature; 150 psi T&P safety relief valve; Precharge equal to static supply pressure.
 For larger applications: Visit amtrol.com, download the AMTROL App or contact Technical Support at 401.535.1216.

EXTROL® Quick Sizing

Boiler	Type of Radiation			
	Finned Baseboard or Radiant Panels	Convectors or Unit Heaters	Radiators Cast Iron	Baseboard Cast Iron
Net Output in 1000'S of BTU/Hr.				
MBH	Use Model	Use Model	Use Model	Use Model
25	EX-15	EX-15	EX-15	EX-15
50	EX-15	EX-15	EX-30	EX-30
75	EX-30	EX-30	EX-30	EX-60
100	EX-30	EX-30	EX-60	EX-60
125	EX-30	EX-60	EX-60	EX-90
150	EX-30	EX-60	EX-90	EX-90
175	EX-60	EX-60	SX Series	SX Series
200	EX-60	EX-60	SX Series	SX Series
250	EX-60	EX-90	SX Series	SX Series
300	EX-90	SX Series	SX Series	SX Series

Sizing based on: 12 psig Fill; 30 psig Relief Valve; 200°F Average Temperature.
 For sizing with fluids other than water: Visit amtrol.com, download the AMTROL App or contact Technical Support at 401-535-1216.

QUICK SIZING



PRODUCT	MODELS	DURATION (from date of purchase)
WATER SYSTEMS		
Well-X-Trol® Residential Well Tanks	WX	Seven (7) Year Limited Warranty*
Well-X1® Constant Pressure System	WX1	Seven (7) Year Limited Warranty (Tank)* Two (2) Year Limited Warranty (Control)
CH, WF & PL Well Tanks	All	Five (5) Year Limited Warranty
Guardian CP® Digital Control	DC2	Two (2) Year Limited Warranty
Reverse Osmosis (RO) Tanks	RO	Five (5) Year Limited Warranty
Retention Tanks	ERTG	Three (3) Year Limited Warranty
AMTROL Pressuriser®	RP	Two (2) Year Limited Warranty
PLUMBING & HEATING		
Extrol® Expansion Tanks	EX, RX & SE SX	Five (5) Year Limited Warranty One (1) Year Limited Warranty
Fill-Trol® Tanks	FT	Five (5) Year Limited Warranty
Thermal Expansion Tanks	ST-5 through ST-25V ST-30V through ST-210V T	Five (5) Year Limited Warranty One (1) Year Limited Warranty One (1) Year Limited Warranty
Mini-Trol® Diatrol®	All All	Five (5) Year Limited Warranty Five (5) Year Limited Warranty (Residential)
HOT WATER MAKERS®		
BoilerMate® Hot Water Makers	CH & WH-41	Six (6) Year Limited Warranty on Heat Exchanger and Tank Assembly Only. Limited Lifetime Upgrade Option Available. See Literature for Upgrade Information.
HYDROMAX® Hot Water Makers	HM	Seven (7) Year Limited Warranty on Heat Exchanger and Tank Assembly Only. Limited Lifetime Upgrade Option Available. See Literature for Upgrade Information.
Ener-G-Net™ Control		Two (2) Year Limited Warranty
Premier™ Hot Water Makers	WH-7, WHS, DC & S	Five (5) Year Limited Warranty in Commercial Applications. Ten (10) Year Limited Warranty in Residential Applications on Heat Exchanger and Tank Assembly Only.
ALL OTHER		
All Other Products, Components and Parts	If not specified above including Hot Water Maker components and parts other than the Heat Exchanger and Tank Assembly.	One (1) Year Limited Warranty

For detailed warranty information, please visit www.amtrol.com

All dimensions and weights listed are approximate.

*Units manufactured April 1, 2010 or later.



1400 Division Road, West Warwick, RI USA 02893

T: 800.426.8765 F: 800.293.1519

www.amtrol.com